



4. fejezet

# Bútordíszítő elemek és dekorációs anyagok

## 4.2 • Tartalomjegyzék

4.3	Fogantyúprofilok, Gola profilrendszer
4.6	Bútorfogantyúk
4.170	Fogasok, fogassorok
4.201	Bútorfogantyúk és fogasok cikkszám táblázata
4.210	Díszlécek, díszidomok
4.211	Struktúrlemezek

### Útmutató

A termék jelölése: **Terméknév**

Cikkszám jelölése: **00008904200**





A bútorfogantyúkat és fogasokat ábrázoló méretezett műszaki rajzok az adott termék befoglaló méretei, illetve a furattávolságok tekintetében adnak pontos információt. A termék formai megjelenése csak tájékoztató jellegű.

A struktúrlemezek, perforált struktúrlemezek, tükörfóliák és a struktúrlemezek élzárásához használatos profilok szállítási határidejét és árát visszaigazolásunk tünteti fel.

A gyártók folyamatos termékfejlesztése következtében termékeink kismértékben módosulhatnak a katalógusban megjelenő képeket. A termékek nem szakszerű beszereléséből adódó károkért felelősséget nem vállalunk.

Amennyiben a katalógusban látható színek, színminták és a termékek valódi színe esetében némi eltérés tapasztalható, ez a nyomdai technológia és az alkalmazott anyagok jellegéből adódhat. Az esetleges nyomdai hibákért felelősséget nem vállalunk!

Bizonyos termékek esetében az alábbi jelölésekkel könnyítjük meg a választást:

-  **Exkluzív** • Magas minőségű, igényes formatervezésű termék.
-  **Kiváló ár-érték arány** • Kedvező árfekvésű, jó minőséget képviselő termék.
-  **Legkedvezőbb ár** • Kínálatunk legolcsóbb terméke az adott kategóriában.
-  **Nemesacél** • A jelölt termékek rozsdamentes nemesacélból készültek.

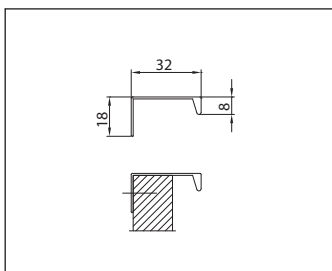
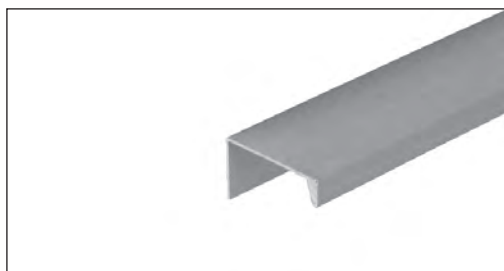

### L 806A - alumínium

fogantyúprofil  
Rendelhető 3 fm-es számban.  
Fiókok szerelésére alkalmas.  
Nyíló ajtók felső-, ill. alsó élére szerelve csak speciális pánt (5.5-5.6. old.) segítségével alkalmazható.

**00000652200**

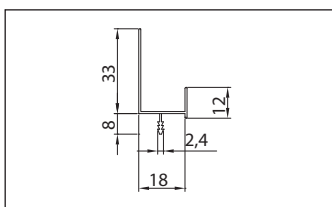
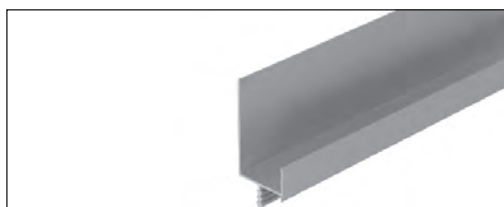

### L 807A - alumínium

fogantyúprofil  
Rendelhető 3 fm-es számban.  
Hagyományos nyíló- és bukóajtók, valamint fiókok szerelésére alkalmas.

**00000652210**

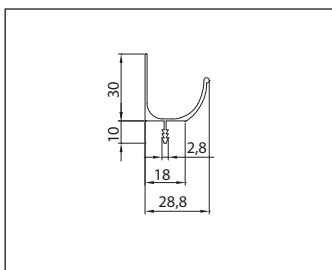
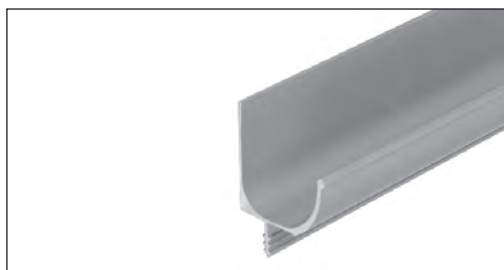

### L 808A - alumínium

fogantyúprofil  
Rendelhető 3 fm-es számban.  
Fiókok szerelésére alkalmas.  
Nyíló ajtók felső-, ill. alsó élére szerelve csak speciális pánt (5.5-5.6. old.) segítségével alkalmazható.

**00000652220**



## 4.4 • Bútorfogantyúk • Gola profilrendszer, fogantyú nélküli megoldásokhoz

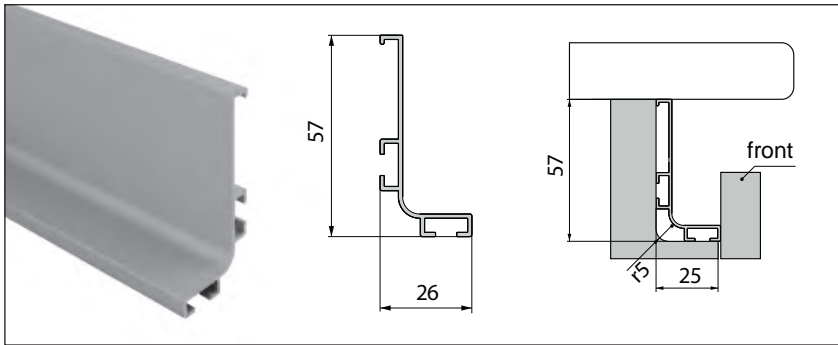

### ■ Gola felső profil

alumínium  
rendelhető 4200 mm-es szálban

**00000691000**

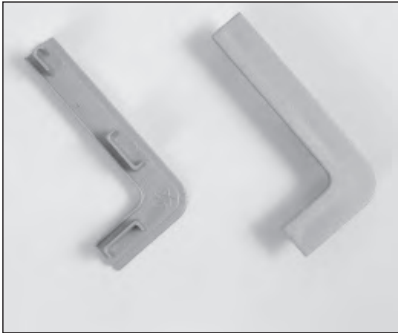

### ■ Külső végzáró felső szett

műanyag

**00000691010**



### ■ Külső végzáró felső szett

alumínium

**00000691020**



### ■ Belső végzáró felső szett

műanyag

**00000691030**

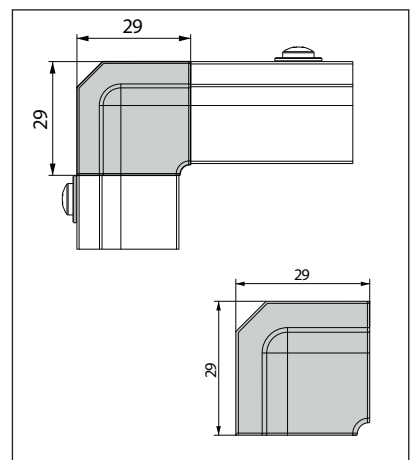
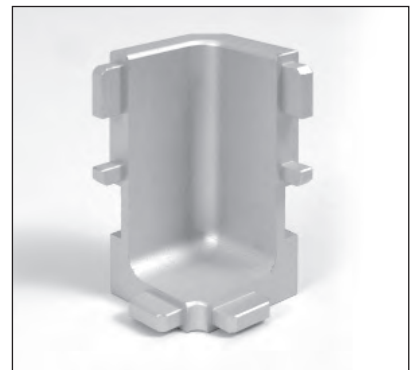

### ■ Belső sarok

alumínium

**00000691040**





**Gola közbenső profil**

alumínium  
rendelhető 4200 mm-es szálban

00000691100

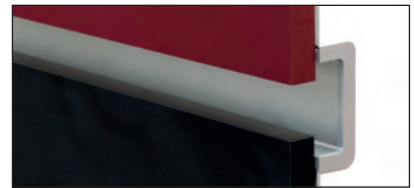
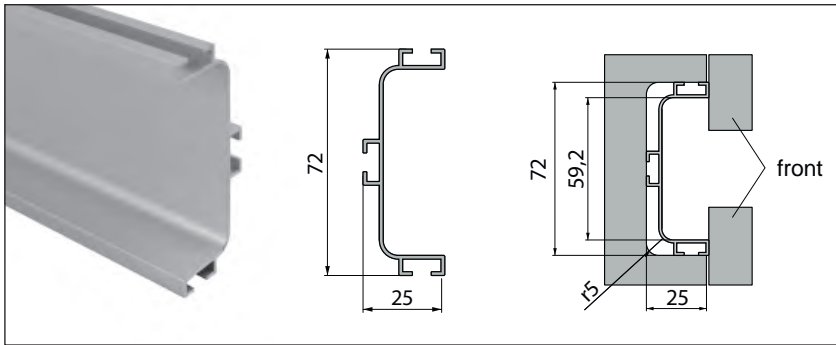

**Külső végzáró közbenső szett**

műanyag

00000691110

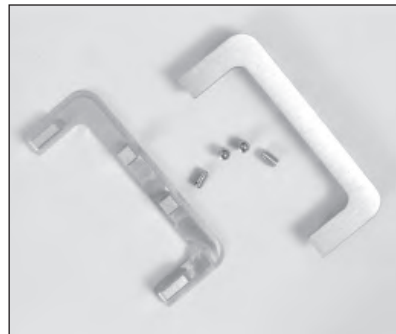

**Külső végzáró közbenső szett**

alumínium

00000691120



**Belső végzáró közbenső szett**

műanyag

00000691130

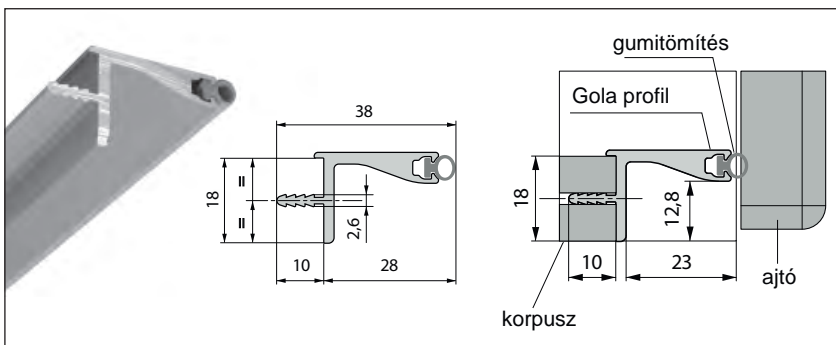

**Gola felsőszekrény vízszintes profil**

alumínium  
ütközéscsillapító gumi csíkkal  
rendelhető 4200 mm-es szálban

00000691200

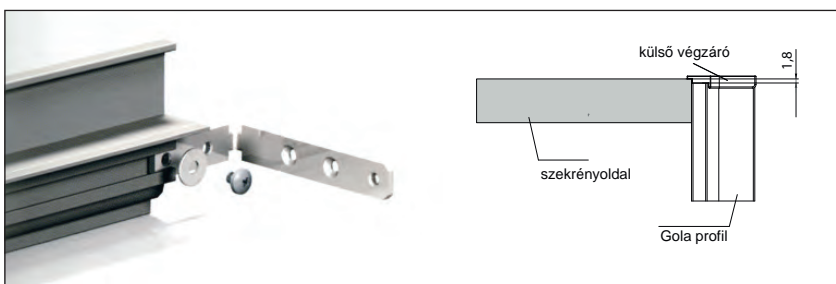

**Szerelési segédlet Gola profilokhoz**

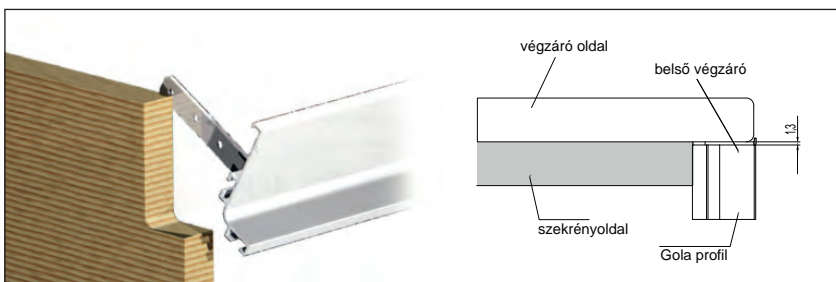

**Rögzítőlemez csavarral**

felső és közbenső profilokhoz  
A garnitúra 2 db rögzítőlemezt tartalmaz

00000691990

## 4.6 • Bútorfogantyúk



■ 580.224

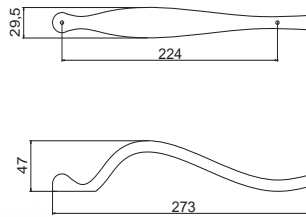
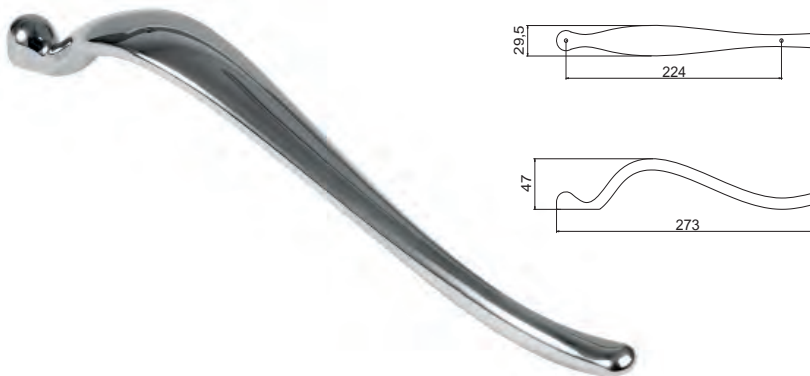

szín	cikkszám
1. fényes elefántcsont	00007552370
2. ezüst	00007552371
3. króm	00007552372



■ 0006.192

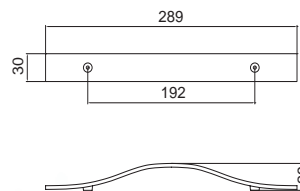
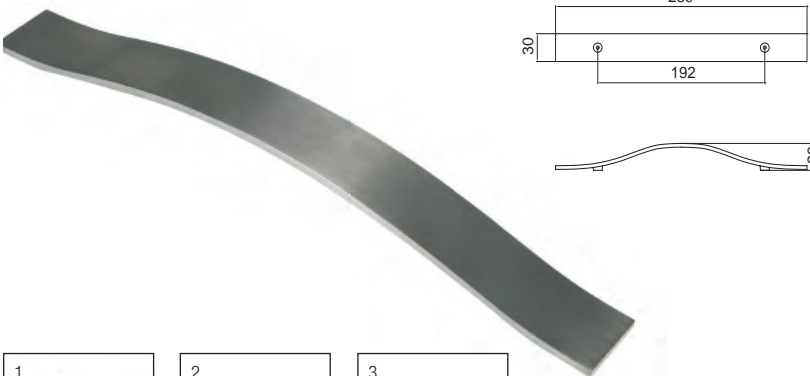

szín	cikkszám
1. nikkelt	00007552380
2. króm	00007552381
3. matt alumínium	00007552382



■ 187.224

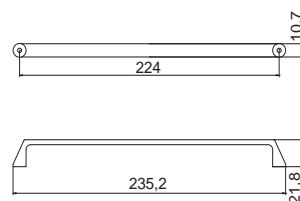
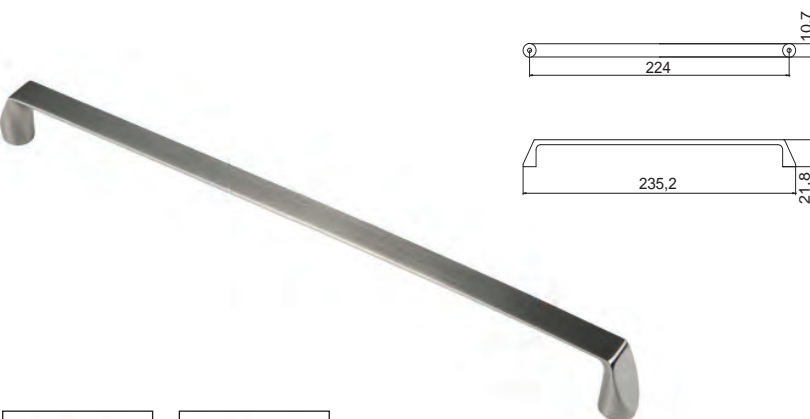

szín	cikkszám
1. nikkelt	00007552410
2. matt alumínium	00007552411

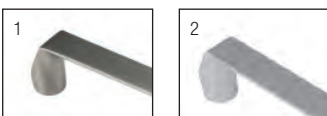



## 187.160

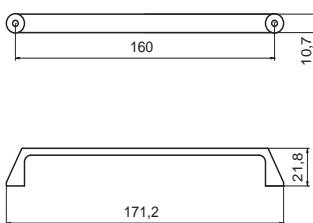

szín	cikkszám
1. nikkell	00007552400
2. matt alumínium	00007552401

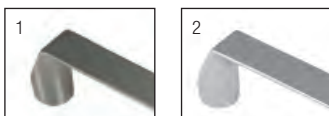

## 187.096

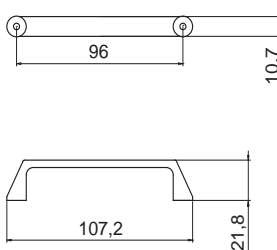

szín	cikkszám
1. nikkell	00007552390
2. matt alumínium	00007552391

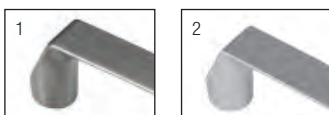

## 706.035

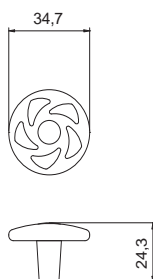

szín	cikkszám
1. antik Firenze	00007552460
2. arany antikolt krém	00007552461
3. ezüst	00007552462



## 4.8 • Bútorfogantyúk



712.000

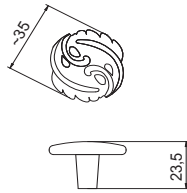

szín	cikkszám
1. antik firenze	00007552450
2. arany antikolt krém	00007552451



719.000

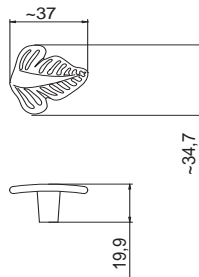

szín	cikkszám
1. antik firenze	00007552420
2. arany antikolt krém	00007552421



4

719.128



szín	cikkszám
1. antik firenze	00007552430
2. arany antikolt krém	00007552431

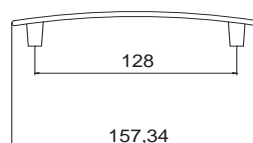



711.064

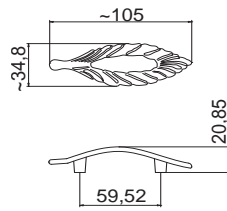

szín	cikkszám
1. antik firenze	00007552440
2. arany antikolt krém	00007552441



M70



szín	cikkszám
1. antikolt krém - arany	00007552470
2. country bronz - barna	00007552480
3. antik firenze - arany	00007552490

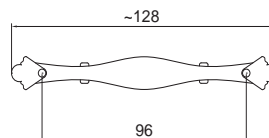
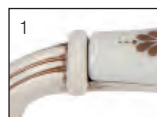
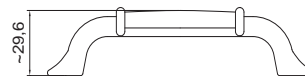

P88

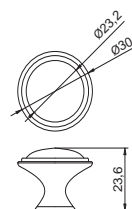

szín	cikkszám
1. antikolt krém - arany	00007552471
2. country bronz - barna	00007552481
3. antik firenze - arany	00007552491





## 4.10 • Bútorfogantyúk



### ■ A028 - fém

alumínium

méret (mm)	cikkszám
295	00007653440
395	00007653450
595	00007653460

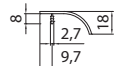
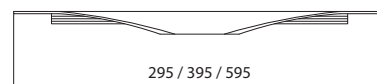
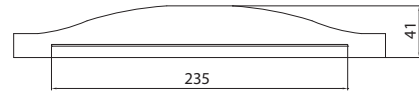

### ■ A027 - fém

alumínium

méret (mm)	cikkszám
295	00007653410
395	00007653420
595	00007653430

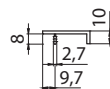
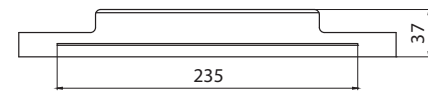



## 1406 - inox - rozsdamentes acél



méret	cikkszám
96	00007310200
128	00007310210
160	00007310220

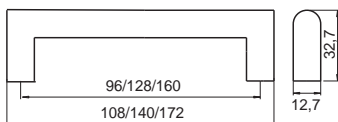

Hossz.	Furattáv.
108	96
140	128
172	160

## 902-24 - inox - rozsdamentes acél

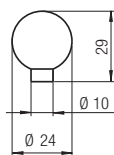

méret	cikkszám
D: 24 mm, H: 29 mm	00007310040

## 904-12 - inox - rozsdamentes acél

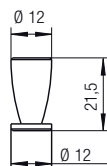

méret	cikkszám
D: 12 mm, H: 21,5 mm	00007310050

## 1404-18 - inox - rozsdamentes acél

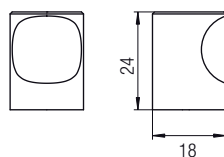

méret	cikkszám
D: 18 mm, H: 24 mm	00007310060

## 2279-18 - inox - rozsdamentes acél



méret	cikkszám
D: 18 mm, H: 15 mm	00007310360

## 2277-10 - inox - rozsdamentes acél

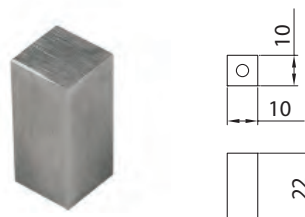

méret	cikkszám
10x10x22 mm	00007310350

## 4.12 • Bútorfogantyúk



### 901 - inox - rozsdamentes acél

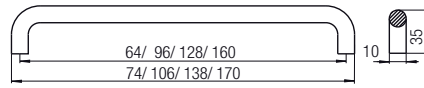

méret	cikkszám
64	00007310100
96	00007310110
128	00007310120
160	00007310130

Hossz. Furattáv.



### 1585 - inox - rozsdamentes acél

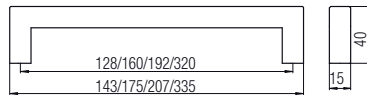

méret	cikkszám
128	00007310000
160	00007310010
192	00007310020
320	00007310030

Hossz. Furattáv.

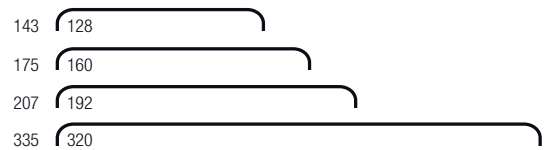

### 1407 - inox - rozsdamentes acél

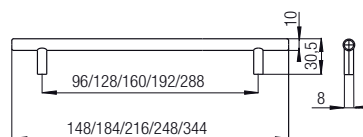

méret	cikkszám
96	00007310300
128	00007310310
160	00007310320
192	00007310330
288	00007310340

Hossz. Furattáv.

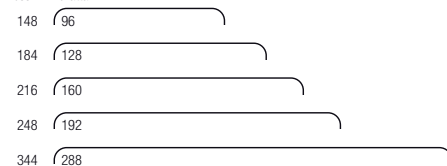

**885 - fém**

matt nikkel

méret (mm)	cikkszám
208	00007303800
240	00007303810
320	00007303820
368	00007303830
416	00007303840
512	00007303850
559	00007303860
635	00007303870
688	00007303880
816	00007303890
863	00007303900
1449	00007303910

Hossz Furattáv.

208	128
240	160
320	240
368	288
416	336
512	432
559	480
635	552
688	608
816	736
863	784
1449	684

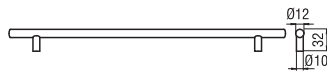



## 4.14 • Bútorfogantyúk

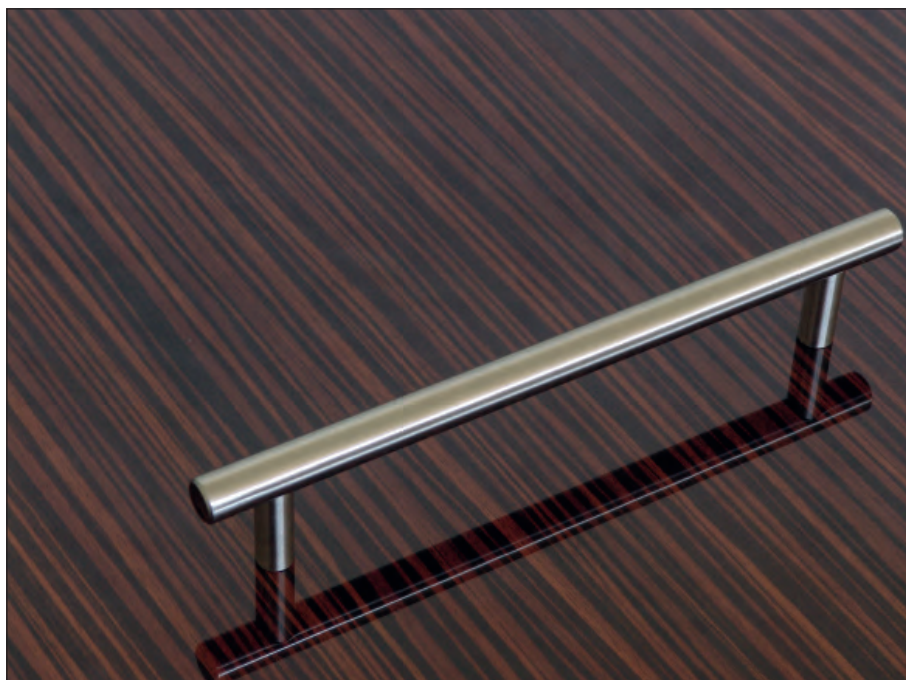

**E037** - fém

nikkel

méret (mm)	cikkszám
136	00007650876
168	00007650880
200	00007650890
232	00007650892
264	00007650895
296	00007650897
328	00007650900
360	00007650905
392	00007650910
424	00007650915
488	00007650920
600	00007650930
700	00007650940
800	00007650950

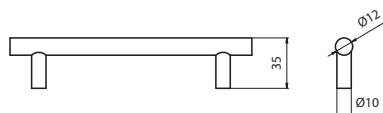
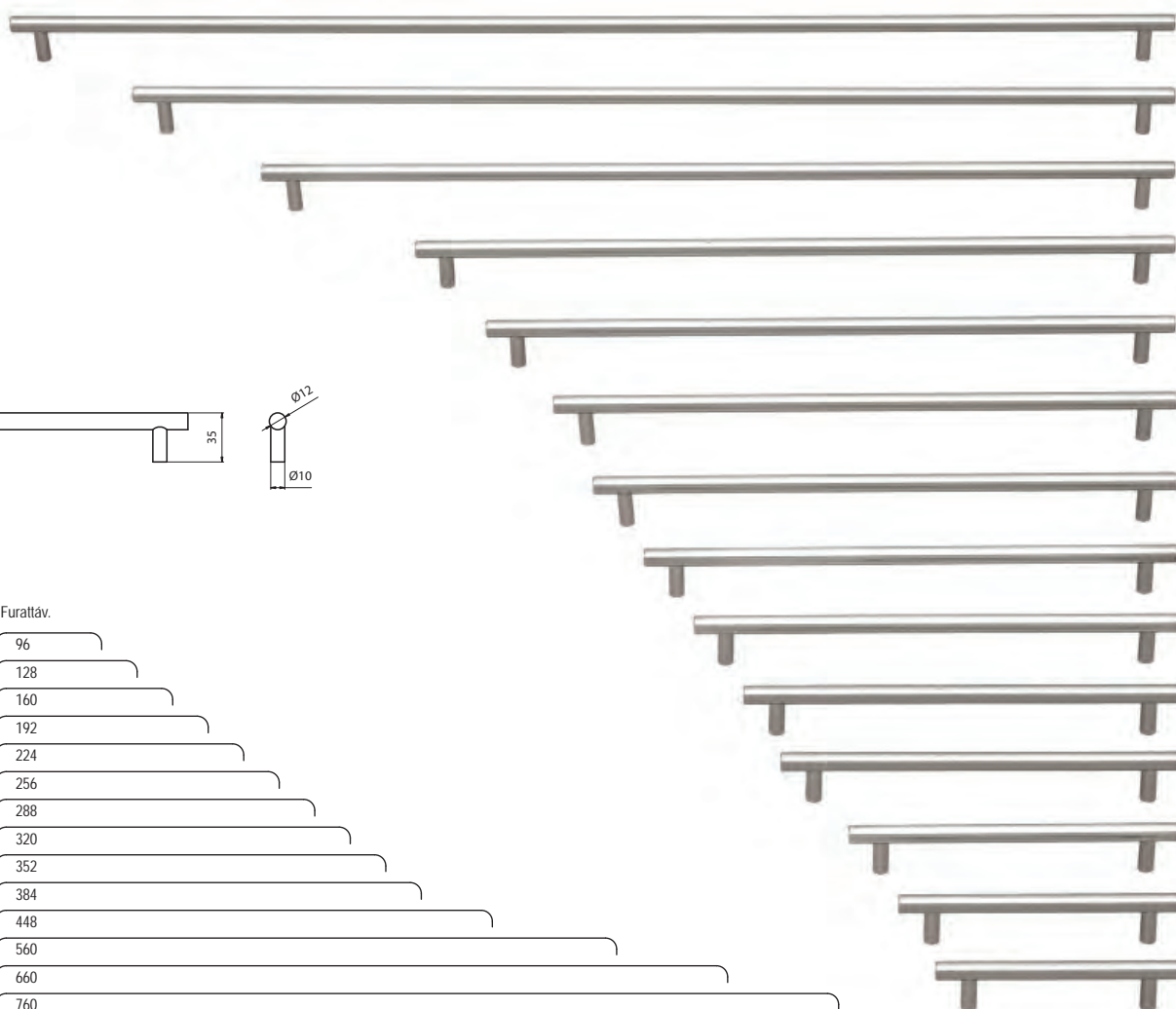

Hossz. Furattáv.

136	96
168	128
200	160
232	192
264	224
296	256
328	288
360	320
392	352
424	384
488	448
600	560
700	660
800	760





**A001** - fém

alumínium

méret (mm)	cikkszám
146	00007650000
178	00007650010
210	00007650020
242	00007650030
274	00007650040
306	00007650043
338	00007650046
370	00007650050
402	00007650053
434	00007650056
530	00007650060
626	00007650063

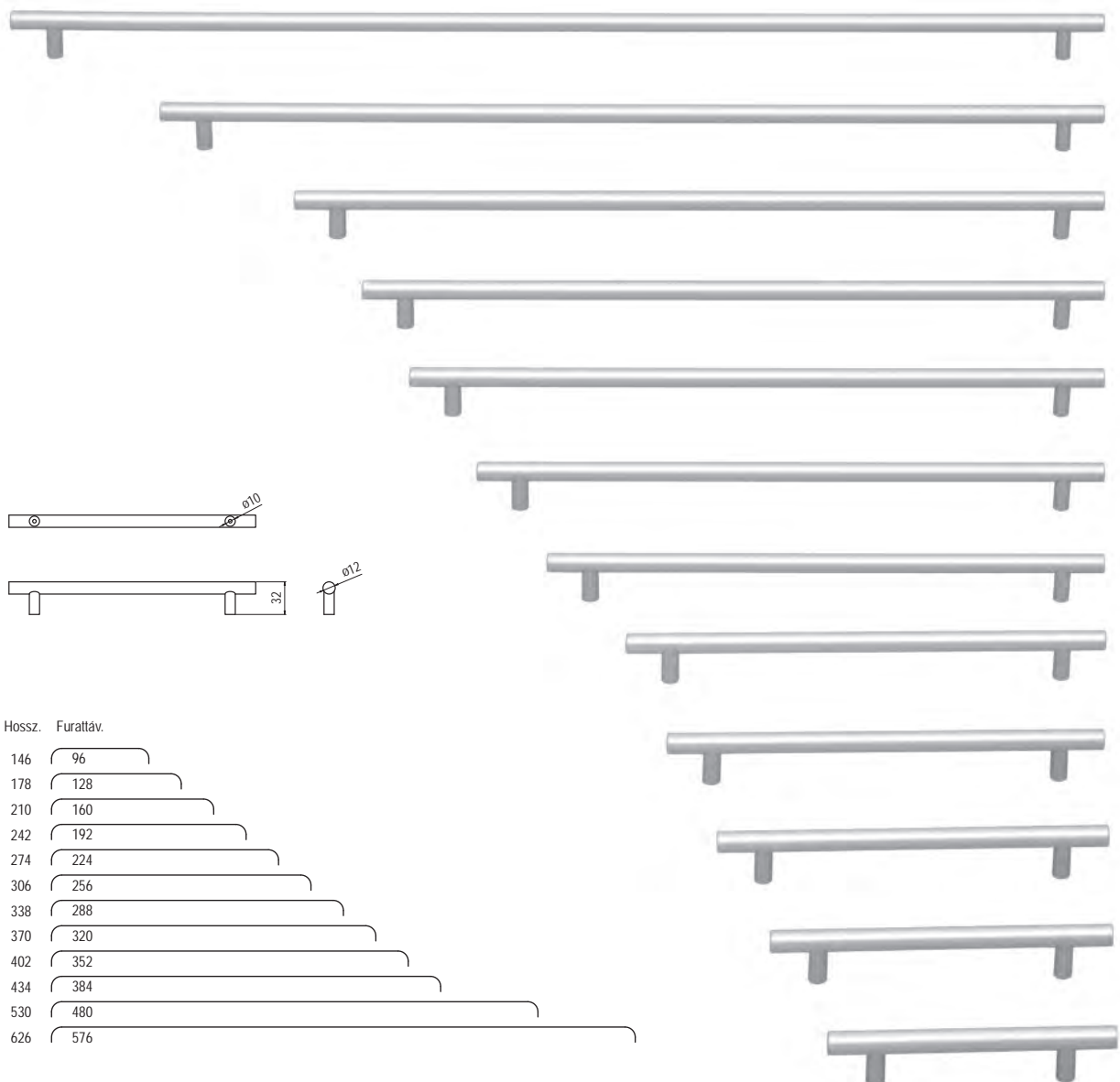

Hossz. Furattáv.

146	96
178	128
210	160
242	192
274	224
306	256
338	288
370	320
402	352
434	384
530	480
626	576

## 4.16 • Bútorfogantyúk

### A003 alumínium - fém

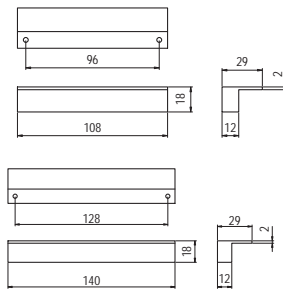

méret (mm)	cikkszám
108	00007650110
140	00007650120

### A005 alumínium - fém

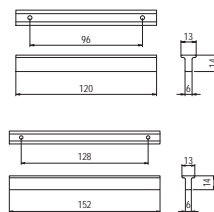

méret (mm)	cikkszám
120	00007650150
152	00007650160

### A006 alumínium - fém

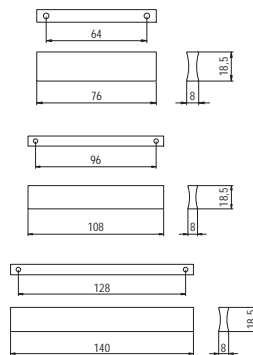

méret (mm)	cikkszám
76	00007650170
108	00007650180
140	00007650190

### A008 alumínium - fém

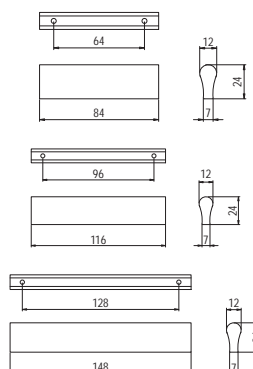

méret (mm)	cikkszám
84	00007650230
116	00007650240
148	00007650250

## A009 alumínium - fém

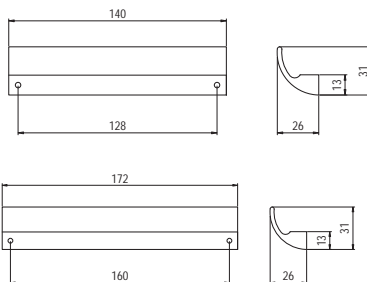

méret (mm)	cikkszám
140	00007650260
172	00007650270

## A010-128 - fém

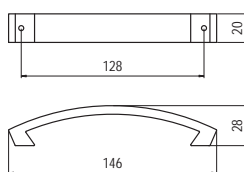

szín	cikkszám
alumínium	00007650290

## A013-128 - fém

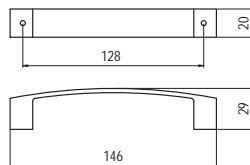

szín	cikkszám
alumínium	00007650320



## A025 - alumínium - fém



Hossz.	Furattáv.
118	96
150	128
182	160
214	192

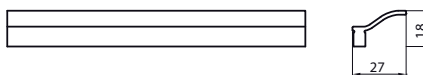

méret	cikkszám
96	00007653330
128	00007653340
160	00007653350
192	00007653360

## A026 - alumínium - fém

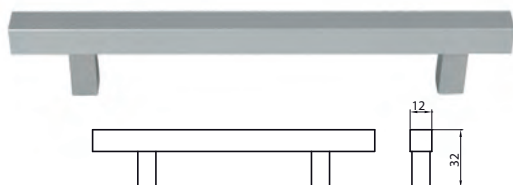

Hossz.	Furattáv.
156	96
188	128
220	160
252	192



méret	cikkszám
96	00007653370
128	00007653380
160	00007653390
192	00007653400

## 4.18 • Bútorfogantyúk

### A015 - alumínium - fém

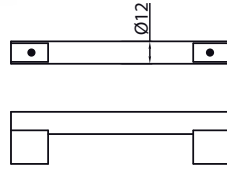

méret	cikkszám
96	00007653030
128	00007653040
160	00007653050

Hossz.	Furattáv.
118	96
150	128
182	160

### A016 - alumínium - fém



méret	cikkszám
96	00007653060
128	00007653070
160	00007653080
192	00007653090

Hossz.	Furattáv.
118	96
150	128
182	160
214	192

### A018 - alumínium - fém



méret	cikkszám
96	00007653130
128	00007653140
160	00007653150
192	00007653160

Hossz.	Furattáv.
120	96
152	128
184	160
216	192

### A021 - alumínium - fém



méret	cikkszám
96	00007653200
128	00007653210
160	00007653220
192	00007653230

Hossz.	Furattáv.
126	96
158	128
195	160
234	192

## A024 - alumínium - fém

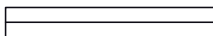
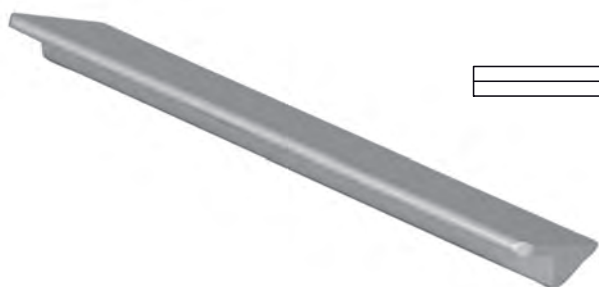

méret	cikkszám
96	00007653290
128	00007653300
160	00007653310
192	00007653320

Hossz.	Furattáv.
120	96
152	128
184	160
216	192

## A023 - alumínium - fém

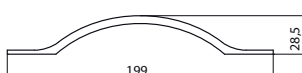
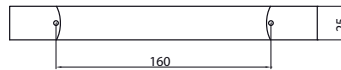
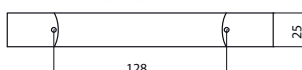
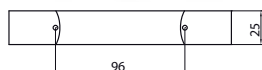

méret	cikkszám
96	00007653260
128	00007653270
160	00007653280

## A019-020 - alumínium - fém



méret	cikkszám
D: 20 mm, H: 30 mm	00007653170

## A020-22 - alumínium - fém



méret	cikkszám
D: 10-25 mm, H: 23 mm	00007653180

## A020-025 - alumínium - fém



méret	cikkszám
D: 18-25 mm, H: 25 mm	00007653190



## 4.20 • Bútorfogantyúk



### 1520-59 - fém

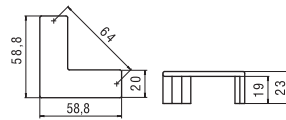

szín	cikkszám
1. matt nikkell	00007304480
2. alumínium	00007304481

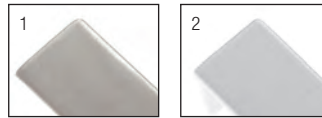

### 1597-52 - fém

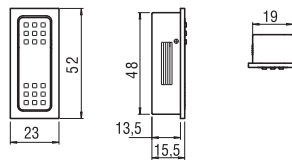

szín	cikkszám
alumínium	00007304710

### 1651 - fém

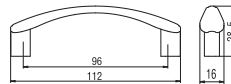

szín	cikkszám
alumínium	00007304740

### 1652-35 - fém

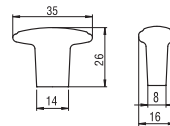

szín	cikkszám
alumínium	00007304760



## C384A - fém

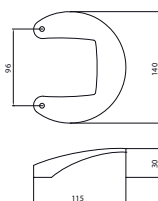

szín	cikkszám
1. galvanizált nikkell	<b>00007500740</b>
2. matt króm	<b>00007500745</b>

## C384B - fém

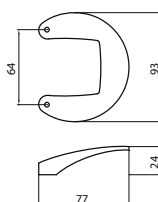

szín	cikkszám
1. galvanizált nikkell	<b>00007500750</b>
2. matt króm	<b>00007500755</b>

## C383A - fém

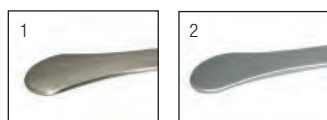

szín	cikkszám
1. galvanizált nikkell	<b>00007500690</b>
2. matt króm	<b>00007500695</b>

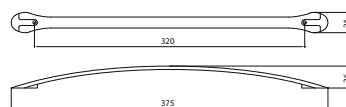

## C383C - fém

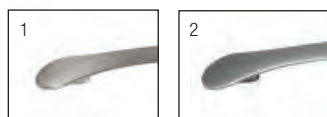

szín	cikkszám
1. galvanizált nikkell	<b>00007500700</b>
2. matt króm	<b>00007500705</b>

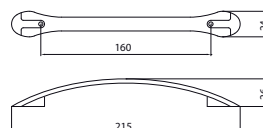

## C380 - fém

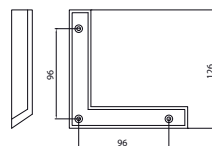
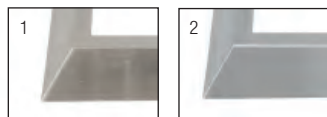

szín	cikkszám
1. galvanizált nikkell	<b>00007500730</b>
2. matt króm	<b>00007500735</b>

## C381A - fém

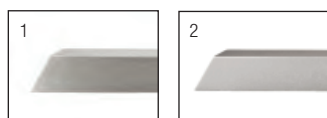

szín	cikkszám
1. galvanizált nikkell	<b>00007500660</b>
2. matt nikkell	<b>00007500665</b>

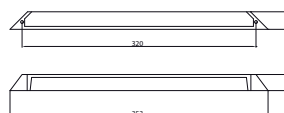

## 4.22 • Bútorfogantyúk

### ■ C381B - fém

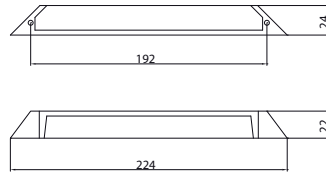
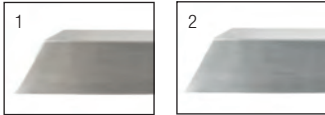

szín	cikkszám
1. galvanizált nikkell	<b>00007500670</b>
2. matt króm	<b>00007500675</b>

### ■ C381C - fém

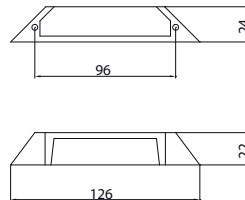
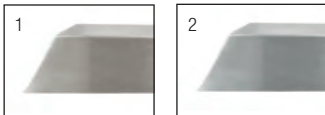

szín	cikkszám
1. galvanizált nikkell	<b>00007500680</b>
2. matt króm	<b>00007500685</b>

### ■ C374B - fém

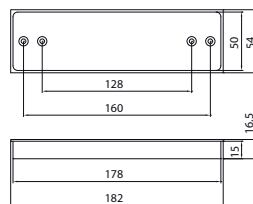
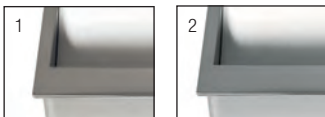

szín	cikkszám
1. galvanizált nikkell	<b>00007500650</b>
2. matt króm	<b>00007500655</b>

### ■ C323 - fém

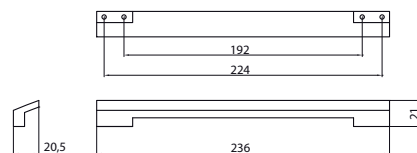
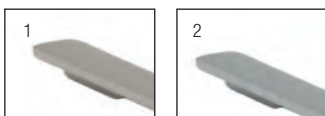

szín	cikkszám
1. galvanizált nikkell	<b>00007500460</b>
2. matt króm	<b>00007500465</b>

## C382C - fém

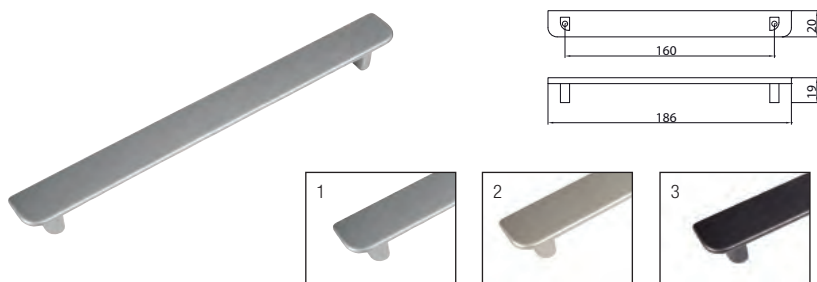

szín	cikkszám
1. matt króm	00007500770
2. matt nikkel	00007500772
3. titanium	00007500777

## C382A - fém

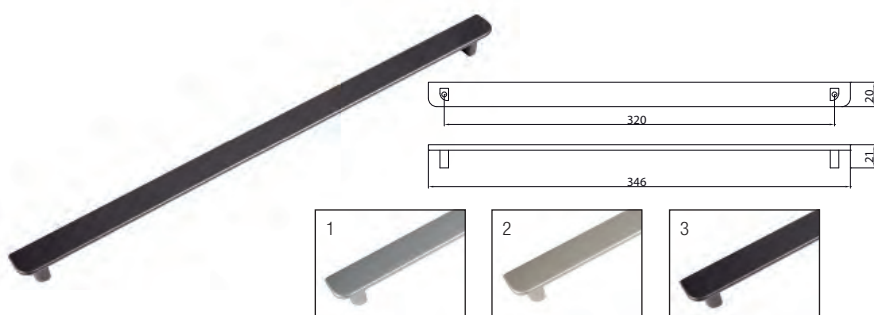

szín	cikkszám
1. matt króm	00007500760
2. matt nikkel	00007500762
3. titanium	00007500767

## C387C - fém

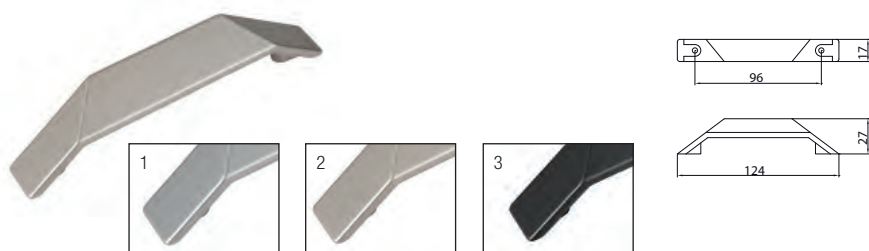

szín	cikkszám
1. matt króm	00007500800
2. matt nikkel	00007500802
3. titanium	00007500807

## C387B - fém

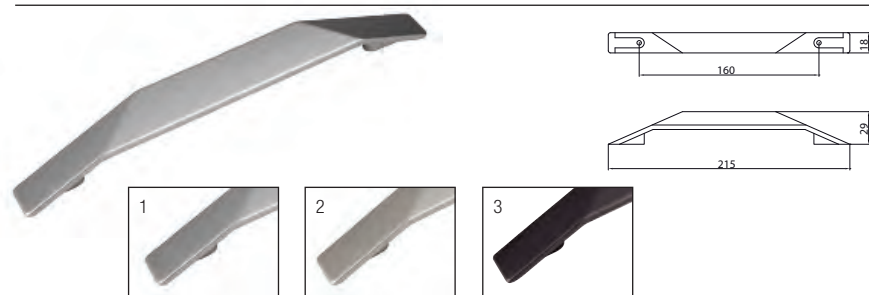

szín	cikkszám
1. matt króm	00007500790
2. matt nikkel	00007500792
3. titanium	00007500797

## C387A - fém

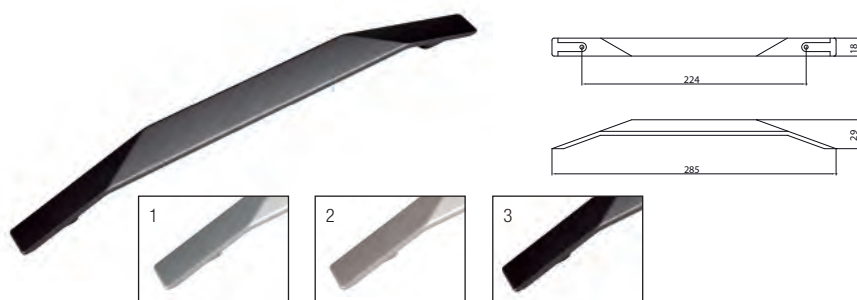

szín	cikkszám
1. matt króm	00007500780
2. matt nikkel	00007500782
3. titanium	00007500787

## 4.24 • Bútorfogantyúk

### ■ C338B - fém

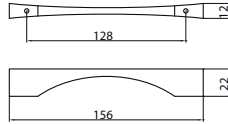
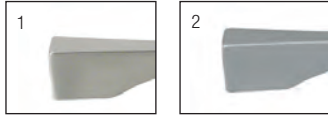

szín	cikkszám
1. galvanizált nikkell	<b>00007500480</b>
2. matt króm	<b>00007500485</b>

### ■ C338A - fém

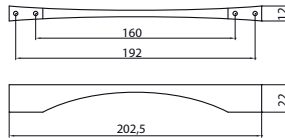
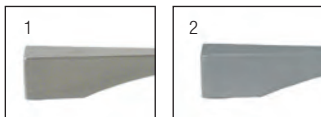

szín	cikkszám
1. galvanizált nikkell	<b>00007500470</b>
2. matt króm	<b>00007500475</b>

### ■ C366B - fém

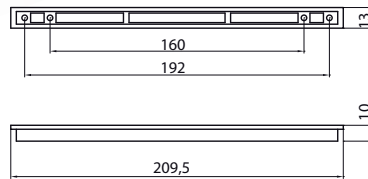
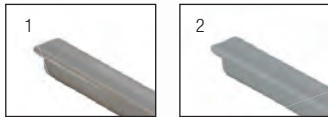

szín	cikkszám
1. galvanizált nikkell	<b>00007500560</b>
2. matt króm	<b>00007500565</b>

### ■ C366C - fém

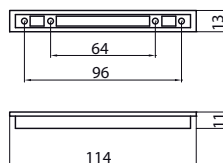
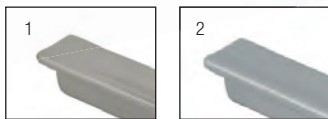

szín	cikkszám
1. galvanizált nikkell	<b>00007500570</b>
2. matt króm	<b>00007500575</b>



## C388C - fém

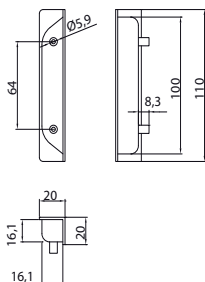

szín	cikkszám
1. matt króm	00007500820
2. matt nikkel	00007500822
3. titanium	00007500827

## C388B - fém

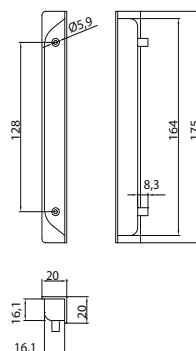

szín	cikkszám
1. matt króm	00007500810
2. matt nikkel	00007500812
3. titanium	00007500817

## C363B - fém

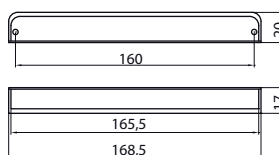

szín	cikkszám
matt króm	00007500550

## C363C - fém

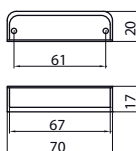

szín	cikkszám
matt króm	00007500555

## C374C - fém

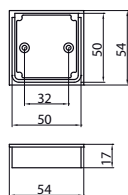
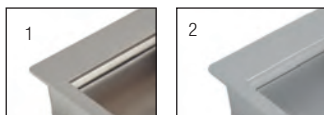

szín	cikkszám
1. galvanizált nikkel	00007500620
2. matt króm	00007500625

## 4.26 • Bútorfogantyúk

### C360A - fém

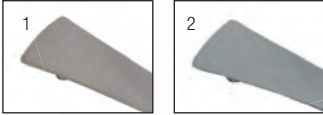

szín	cikkszám
1. galvanizált nikkell	00007500520
2. matt króm	00007500525

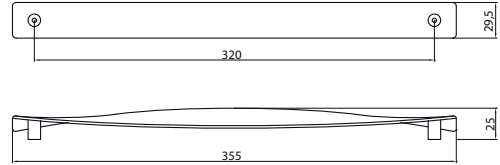

### C360B - fém

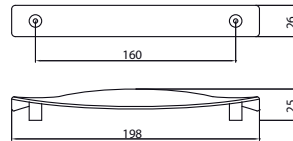
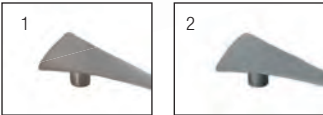

szín	cikkszám
1. galvanizált nikkell	00007500530
2. matt króm	00007500535

### C360C - fém

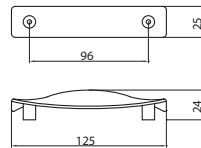
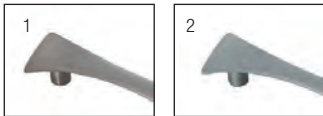

szín	cikkszám
1. galvanizált nikkell	00007500540
2. matt króm	00007500545

### C368A - fém

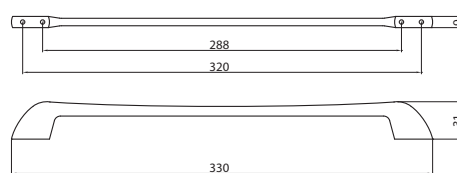
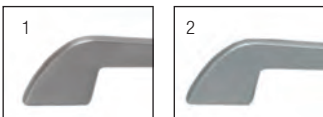

szín	cikkszám
1. galvanizált nikkell	00007500580
2. matt króm	00007500585

### C368B - fém

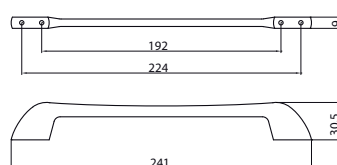
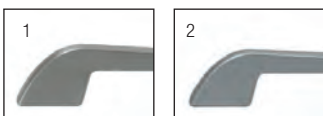

szín	cikkszám
1. galvanizált nikkell	00007500590
2. matt króm	00007500595

## C368C - fém

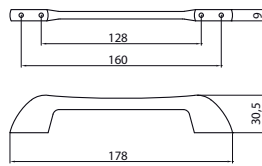
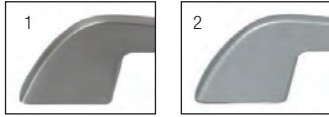

szín	cikkszám
1. galvanizált nikkell	00007500600
2. matt króm	00007500605

## C368D - fém

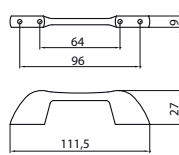
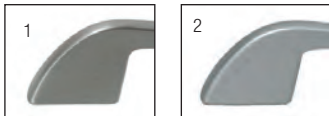

szín	cikkszám
1. galvanizált nikkell	00007500610
2. matt króm	00007500615

## C2033 - fém

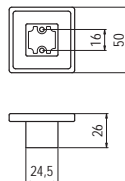
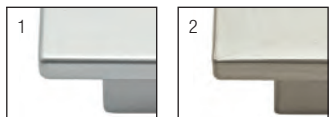

szín	cikkszám
1. matt króm	00007500280
2. galvanizált nikkell	00007500285

## C341 - fém

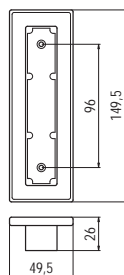
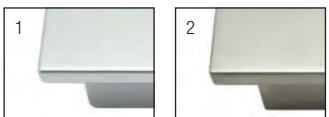

szín	cikkszám
1. matt króm	00007500380
2. galvanizált nikkell	00007500385

## 4.28 • Bútorfogantyúk

### ■ C348A - fém

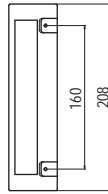

szín	cikkszám
matt króm	<b>00007500330</b>

### ■ C348B - fém

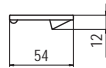
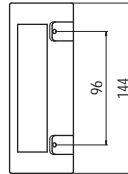
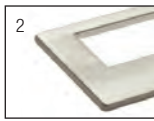
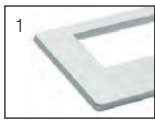

szín	cikkszám
1. matt króm	<b>00007500340</b>
2. galvanizált nikkell	<b>00007500345</b>



## C336 - fém

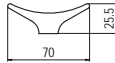
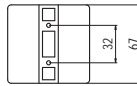

szín	cikkszám
1. matt króm	00007500300
2. galvanizált nikkell	00007500305

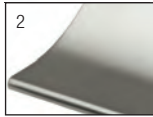
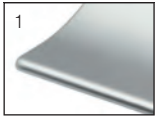

## C352A - fém

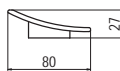
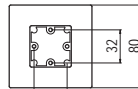

szín	cikkszám
1. matt króm	00007500350
2. galvanizált nikkell	00007500355



## C352B - fém

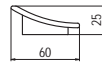
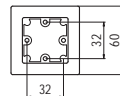

szín	cikkszám
1. matt króm	00007500360
2. galvanizált nikkell	00007500365





## 4.30 • Bútorfogantyúk

### ■ C330 - fém

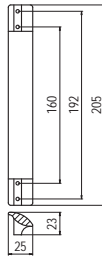
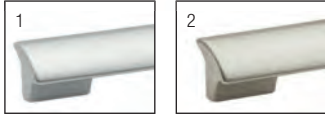

szín	cikkszám
1. matt króm	<b>00007500270</b>
2. galvanizált nikkell	<b>00007500275</b>

### ■ C344 - fém

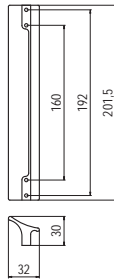
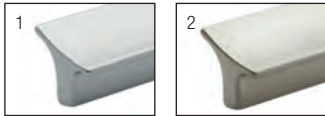

szín	cikkszám
1. matt króm	<b>00007500370</b>
2. galvanizált nikkell	<b>00007500375</b>

### ■ C347A - fém

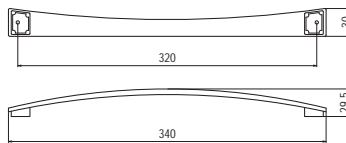

szín	cikkszám
1. matt króm	<b>00007500250</b>
2. galvanizált nikkell	<b>00007500255</b>
3. titánium	<b>00007500257</b>

### ■ C347B - fém

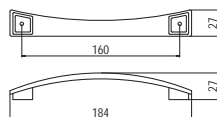

szín	cikkszám
1. matt króm	<b>00007500260</b>
2. galvanizált nikkell	<b>00007500265</b>
3. titánium	<b>00007500267</b>



## C332A - fém

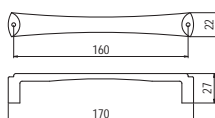
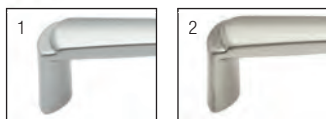

szín	cikkszám
1. matt króm	<b>00007500310</b>
2. galvanizált nikkell	<b>00007500315</b>

## C332B - fém

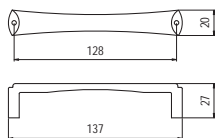
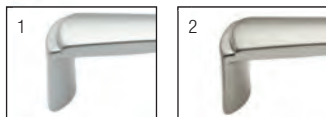

szín	cikkszám
1. matt króm	<b>00007500320</b>
2. galvanizált nikkell	<b>00007500325</b>

## C310 - fém

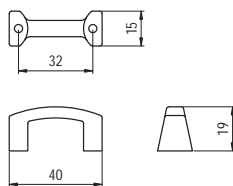

szín	cikkszám
1. matt króm	<b>00007500150</b>
2. matt nikkell	<b>00007500152</b>
3. galvanizált nikkell	<b>00007500155</b>

## C293 - fém

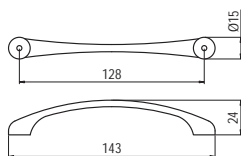

szín	cikkszám
1. matt króm	<b>00007500030</b>
2. matt nikkell	<b>00007500032</b>
3. galvanizált nikkell	<b>00007500035</b>

## 4.32 • Bútorfogantyúk

### ■ C315A - fém

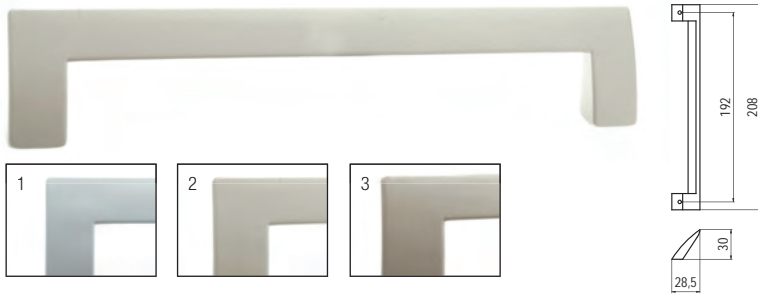

szín	cikkszám
1. matt króm	00007500160
2. matt nikkell	00007500162
3. galvanizált nikkell	00007500165

### ■ C315B - fém

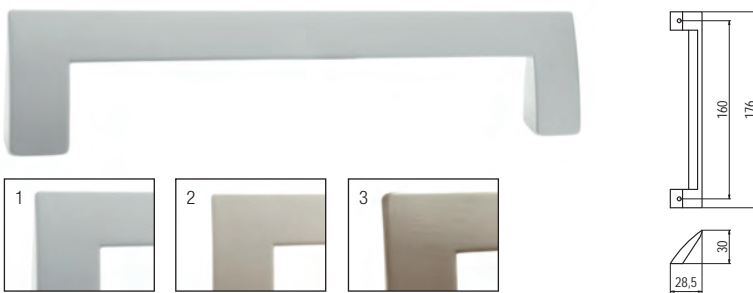

szín	cikkszám
1. matt króm	00007500170
2. matt nikkell	00007500172
3. galvanizált nikkell	00007500175

### ■ C315C - fém

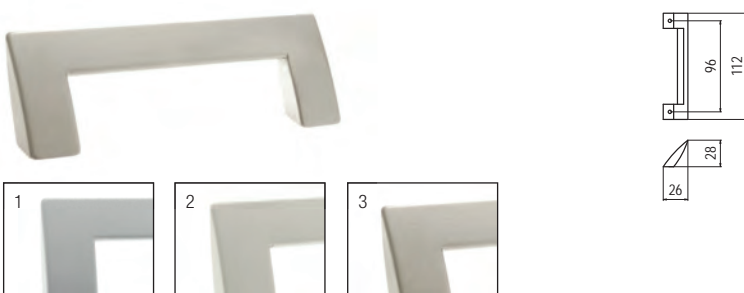

szín	cikkszám
1. matt króm	00007500180
2. matt nikkell	00007500182
3. galvanizált nikkell	00007500185

### ■ C316 - fém

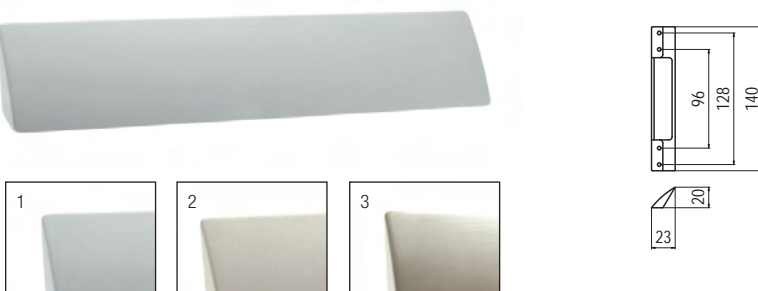

szín	cikkszám
1. matt króm	00007500190
2. matt nikkell	00007500192
3. galvanizált nikkell	00007500195

### ■ C317 - fém

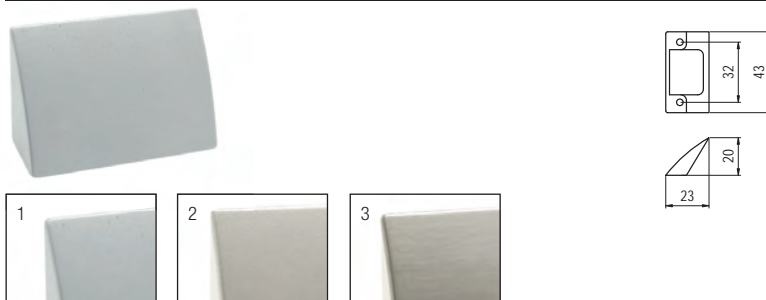

szín	cikkszám
1. matt króm	00007500200
2. matt nikkell	00007500202
3. galvanizált nikkell	00007500205

## C307 - fém

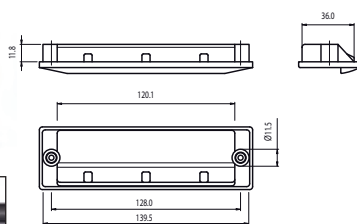

C307 fogantyú bemarási méret:  
139.5 x 36 x 12 mm

szín	cikkszám
1. matt krom	00007500130
2. matt nikkel	00007500132
3. titanium	00007500137

## C303A - fém

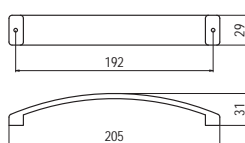
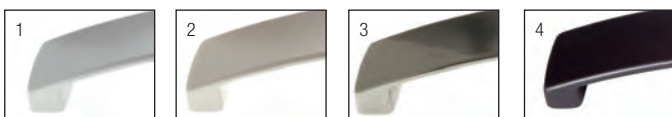

szín	cikkszám
1. matt krom	00007500080
2. matt nikkel	00007500082
3. galvanizált nikkel	00007500085
4. titanium	00007500087

## C303B - fém

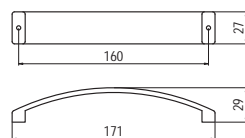
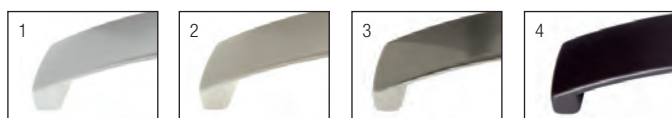

szín	cikkszám
1. matt krom	00007500090
2. matt nikkel	00007500092
3. galvanizált nikkel	00007500095
4. titanium	00007500097

## C303C - fém

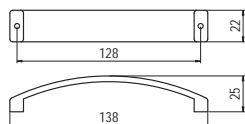
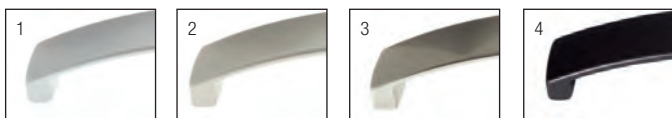

szín	cikkszám
1. matt krom	00007500100
2. matt nikkel	00007500102
3. galvanizált nikkel	00007500105
4. titanium	00007500107

## 4.34 • Bútorfogantyúk

### ■ C335 - fém

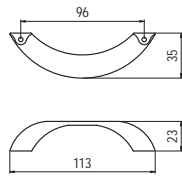

szín	cikkszám
1. matt króm	<b>00007500210</b>
2. matt nikkel	<b>00007500212</b>
3. galvanizált nikkel	<b>00007500215</b>

### ■ C265 - fém

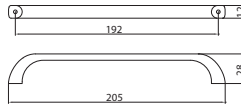

szín	cikkszám
1. matt króm	<b>00007500000</b>
2. matt nikkel	<b>00007500002</b>
3. galvanizált nikkel	<b>00007500005</b>

### ■ C305 - fém

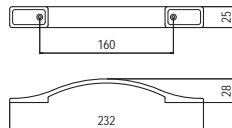

szín	cikkszám
1. matt króm	<b>00007500110</b>
2. matt nikkel	<b>00007500112</b>
3. galvanizált nikkel	<b>00007500115</b>

### ■ C306 - fém

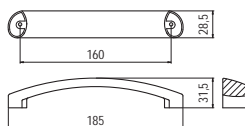

szín	cikkszám
matt króm	<b>00007500120</b>



**CONFALÖNERI**

**MB09098B0** - fém

Design: Roberto Giacomucci

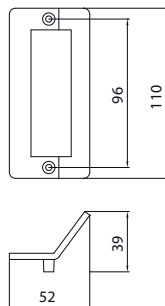

szín	cikkszám
patagónia ezüst	<b>00007590090</b>

**MB09107B0** - fém

Design: Massimo Cavana

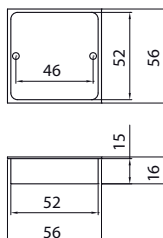

szín	cikkszám
patagónia ezüst	<b>00007590050</b>

**MB09129B0** - fém

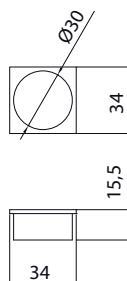

szín	cikkszám
1. patagónia ezüst	<b>00007590060</b>
2. caledonia nikkell	<b>00007590061</b>

**MB0909900** - fém

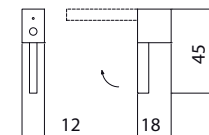

szín	cikkszám
patagónia ezüst	<b>00007590030</b>

## 4.36 • Bútorfogantyúk



CONFAZIONIERI

MB091020 - fém

Design: Massimo Cavana



szín	cikkszám
1. pretória króm	00007590110
2. botswana nikkell	00007590111

MB091420 - fém

Design: Fabio Casiraghi\_Studio Nava

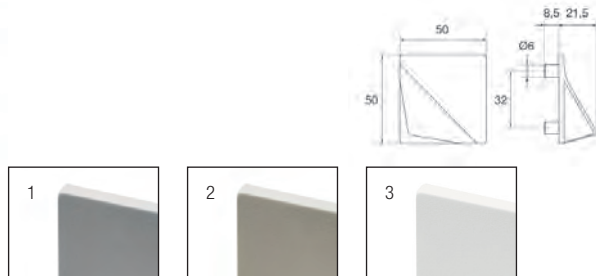

szín	cikkszám
1. patagónia ezüst	00007590120
2. caledonia nikkell	00007590121
3. matt fehér	00007590122

MB091430 - fém

Design: Fabio Casiraghi\_Studio Nava

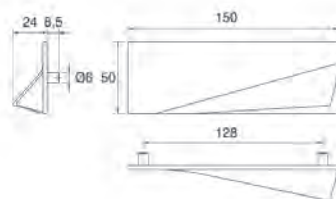

szín	cikkszám
1. patagónia ezüst	00007590130
2. caledonia nikkell	00007590131
3. matt fehér	00007590132

MB091440 - fém

Design: Fabio Casiraghi\_Studio Nava

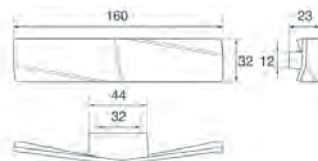

szín	cikkszám
1. patagónia ezüst	00007590140
2. caledonia nikkell	00007590141
3. matt fehér	00007590142

MB091480 - fém

Design: Fabio Casiraghi\_Studio Nava

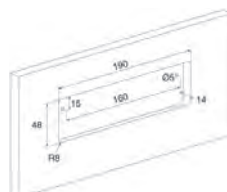

szín	cikkszám
1. patagónia ezüst	00007590150
2. matt fehér	00007590151





**CONFAÖNERI**

■ **MB09045A0** - fém

Design: Franco Guanzioli

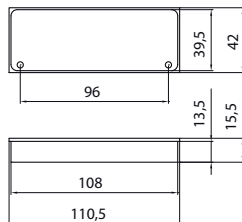

szín	cikkszám
patagónia ezüst	<b>00007590070</b>

■ **MB09078B0** - fém

Design: Massimo Cavana

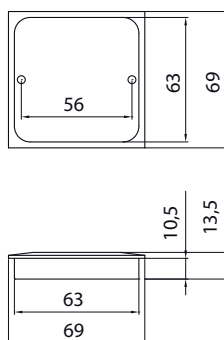

szín	cikkszám
patagónia ezüst	<b>00007590040</b>

■ **MB09132B0** - fém

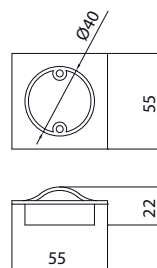
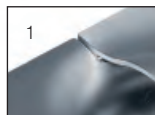
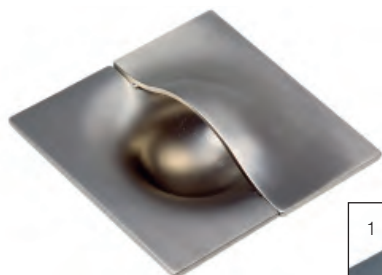

szín	cikkszám
patagónia ezüst	<b>00007590080</b>
caledonia nikkell	<b>00007590081</b>

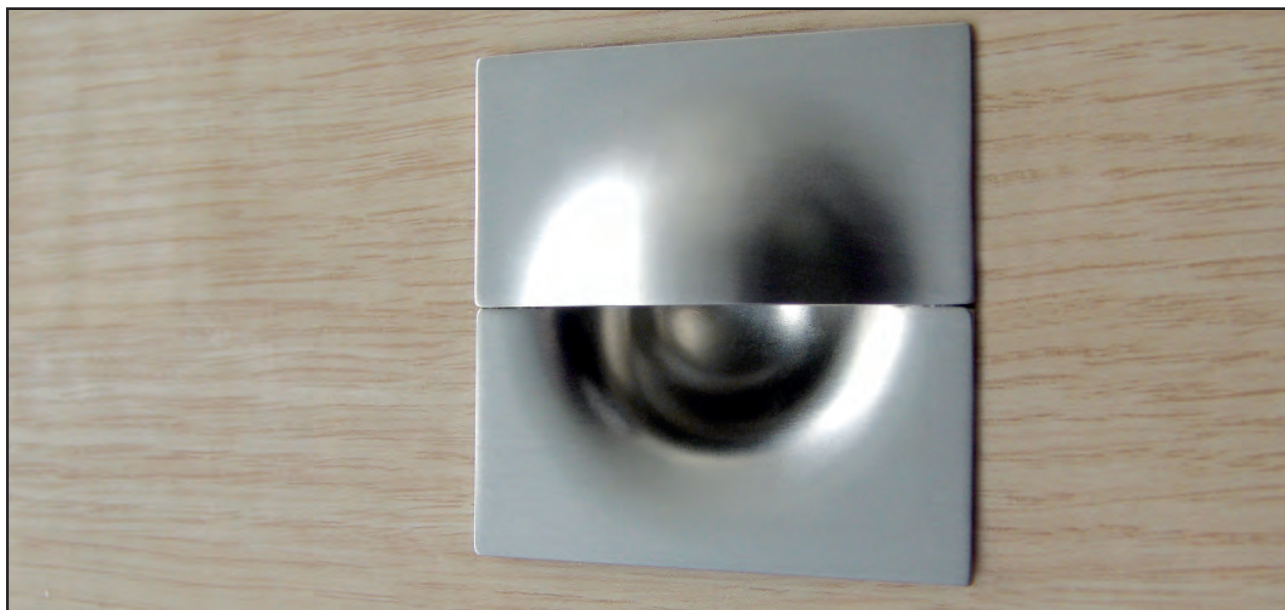

## 4.38 • Bútorfogantyúk

### ■ 2184-137 - fém

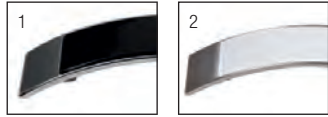
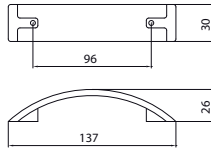

szín	cikkszám
1. króm-fekete	00007306790
2. nikkelfehér	00007306791

### ■ 2184-200 - fém

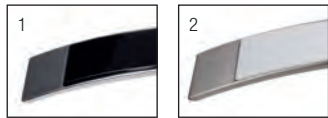
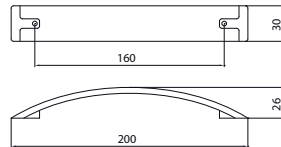

szín	cikkszám
1. króm-fekete	00007306800
2. nikkelfehér	00007306801



### ■ 2113-137 - fém

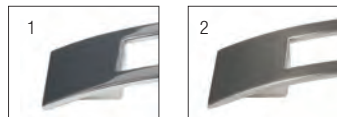
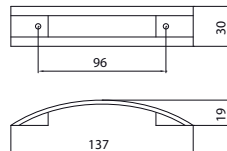

szín	cikkszám
1. króm	00007306700
2. nikkelfehér	00007306701

### ■ 2113-168 - fém

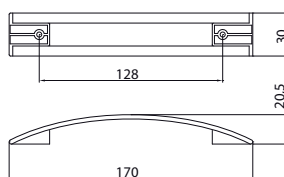

szín	cikkszám
króm	00007305150

## 2198-173 - fém

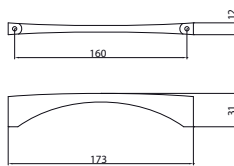
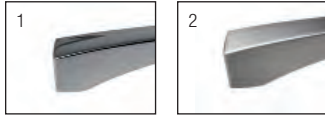

szín	cikkszám
1. króm	00007306770
2. nikkell	00007306771

## 2198-333 - fém

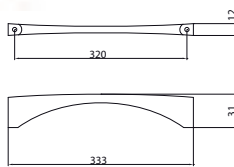
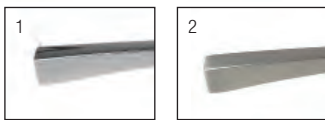

szín	cikkszám
1. króm	00007306780
2. nikkell	00007306781

## 2182 - fém

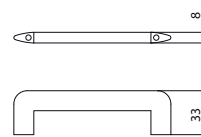

szín	cikkszám
1. króm - 118	00007306640
2. nikkell - 118	00007306641
1. króm - 182	00007306650
2. nikkell - 182	00007306651
1. króm - 342	00007306660
2. nikkell - 342	00007306661

hossz. furattáv

118	96
182	160
342	320



## 4.40 • Bútorfogantyúk

### 2110 - króm - fém

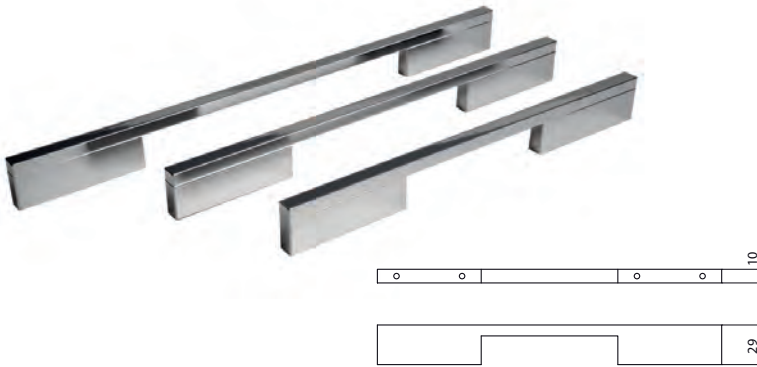

méret	cikkszám
128	00007306710
160	00007306720
224	00007306730

hossz. furattáv

252 (128 / 224)

284 (160 / 256)

348 (224 / 320)

### 2183 - fém



szín	cikkszám
1. króm - 104	00007306670
2. nikkell - 104	00007306671
1. króm - 168	00007306680
2. nikkell - 168	00007306681
1. króm - 328	00007306690
2. nikkell - 328	00007306691

hossz. furattáv

104 (96)

168 (160)

328 (320)

### 2057-75 - fém

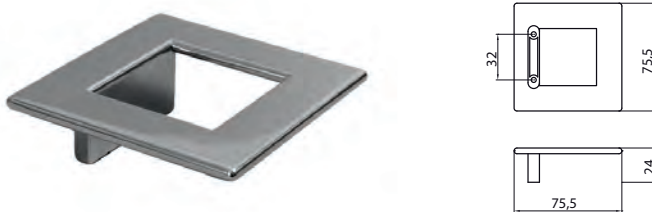

szín	cikkszám
króm	00007305170

### 2108-168 - fém

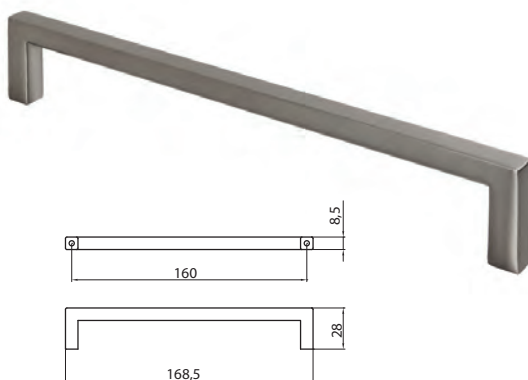

szín	cikkszám
nikkell	00007305180





## 2035-72 - fém

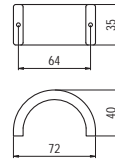
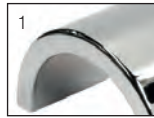

szín	cikkszám
1. króm	00007306600
2. nikkel	00007306601

## 2035-232 - fém

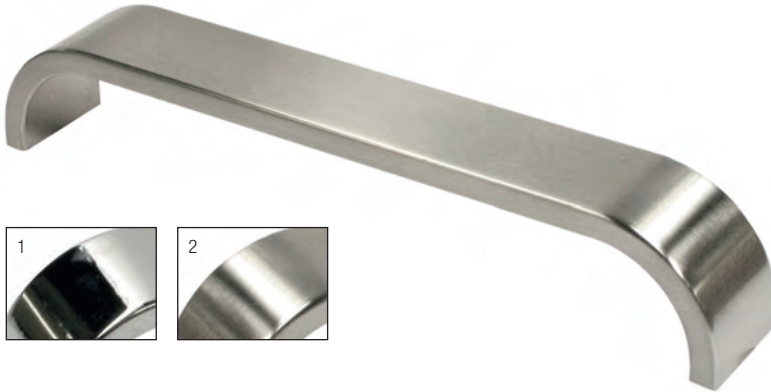

szín	cikkszám
1. króm	00007306610
2. nikkel	00007306611

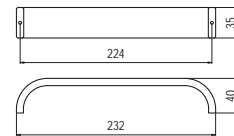

## 2092-65 - fém

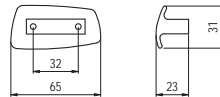
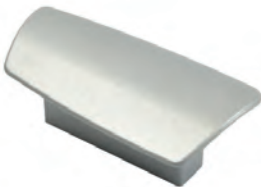

szín	cikkszám
alumínium	00007306620

## 1538-152 - fém

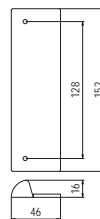

szín	cikkszám
alumínium	00007304510

## 2120-136 - fém

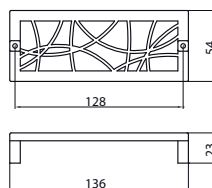

szín	cikkszám
króm	00007305190

## 4.42 • Bútorfogantyúk

### 2040-20 - fém

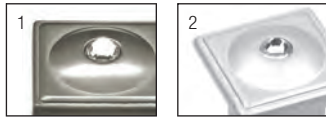

szín	cikkszám
1. nikkell	00007305080
2. alumínium	00007305081

### 2038-110 - fém

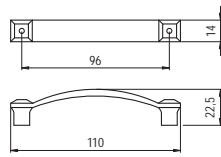
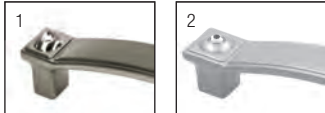

szín	cikkszám
1. nikkell	00007305090
2. alumínium	00007305091

### 2038-142 - fém

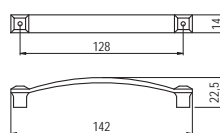
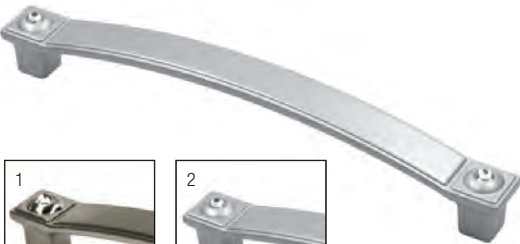

szín	cikkszám
1. nikkell	00007305100
2. alumínium	00007305101

### 1809-110 - fém

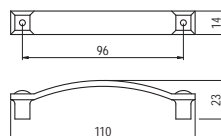
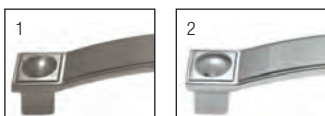

szín	cikkszám
1. nikkell	00007304910
2. króm	00007304911





## 126-128 - fém

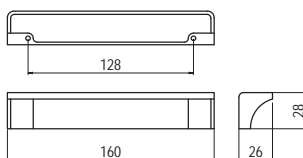

szín	cikkszám
1. matt alumínium	<b>00007550040</b>
2. nikkell	<b>00007550041</b>

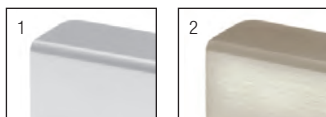

## 138-192 - fém

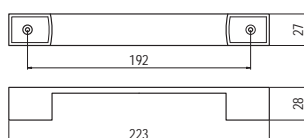

szín	cikkszám
1. matt alumínium	<b>00007550100</b>
2. nikkell	<b>00007550101</b>

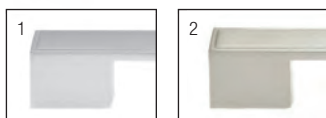

## 169-160 - fém

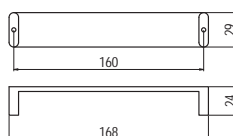

szín	cikkszám
1. matt alumínium	<b>00007550180</b>
2. nikkell	<b>00007550181</b>

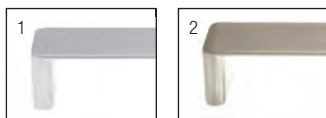

## 169-128 - fém

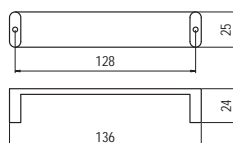

szín	cikkszám
1. matt alumínium	<b>00007550190</b>
2. nikkell	<b>00007550191</b>

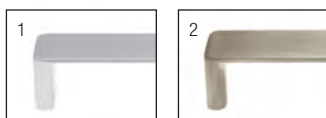

## 180-128 - fém

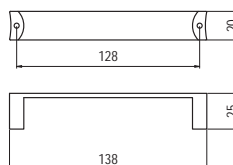

szín	cikkszám
1. matt alumínium	<b>00007550200</b>
2. nikkell	<b>00007550201</b>

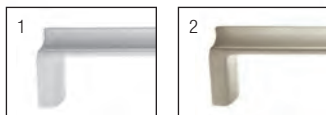

## 4.44 • Bútorfogantyúk



### 154-160 - fém

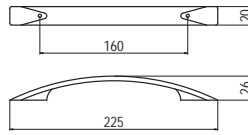

szín	cikkszám
1. matt alumínium	00007550150
2. nikkell	00007550151

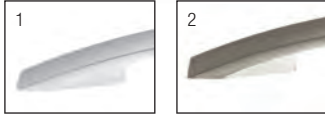

### 300.032 - fém

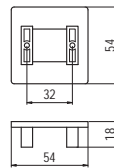

szín	cikkszám
1. matt alumínium	00007551180
2. króm	00007551181
3. nikkell	00007551182

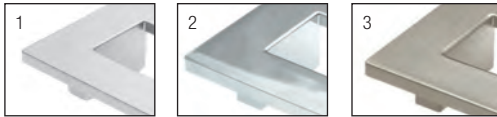

### 005-B32 - fém

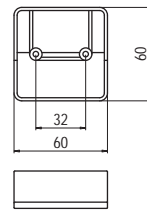
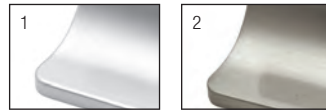

szín	cikkszám
1. matt alumínium	00007551170
2. nikkell	00007551171



### 102-128 - fém

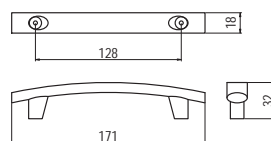

szín	cikkszám
1. matt alumínium	00007550000
2. nikkell	00007550001

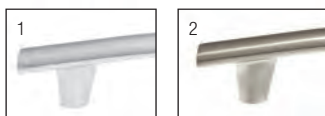



## 145-160 - fém

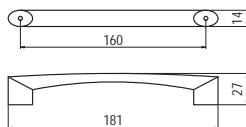

szín	cikkszám
1. matt alumínium	00007550120
2. nikkell	00007550121

## 183-128 - fém

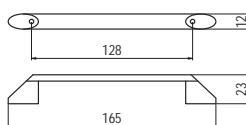
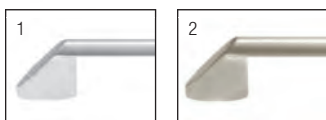

szín	cikkszám
1. matt alumínium	00007550220
2. nikkell	00007550221

## 106-160 - fém

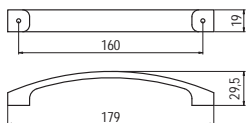
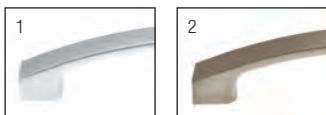

szín	cikkszám
1. matt alumínium	00007550010
2. nikkell	00007550011

## 153-160 - fém

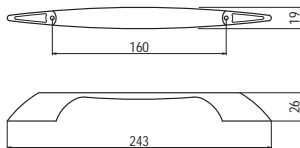
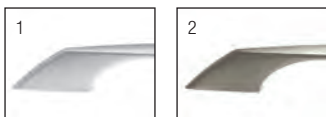

szín	cikkszám
1. matt alumínium	00007550130
2. nikkell	00007550131

## 153-128 - fém

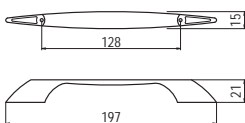
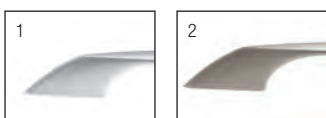

szín	cikkszám
1. matt alumínium	00007550140
2. nikkell	00007550141

## 4.46 • Bútorfogantyúk



■ 541.064 - fém

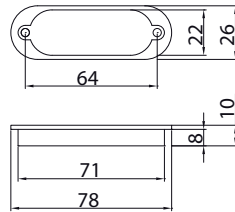

szín	cikkszám
nikkel	<b>00007551710</b>

■ 543.064 - fém

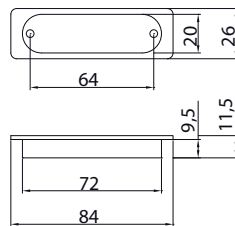

szín	cikkszám
nikkel	<b>00007551720</b>

■ 317.064 - fém

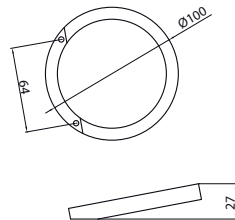
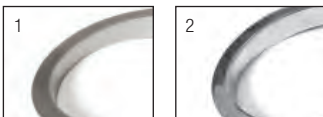

szín	cikkszám
1. nikkel	<b>00007551730</b>
2. króm	<b>00007551731</b>

■ 317.032 - fém

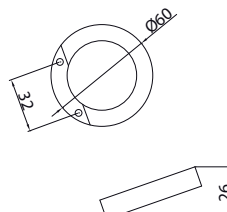

szín	cikkszám
1. nikkel	<b>00007551740</b>
2. króm	<b>00007551741</b>



## 132-160 - fém

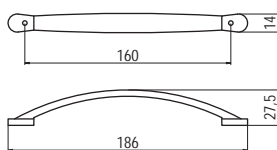

szín	cikkszám
1. matt alumínium	00007550050
2. króm	00007550051
3. nikkel	00007550052
4. antikolt	00007550053



## 132-128 - fém

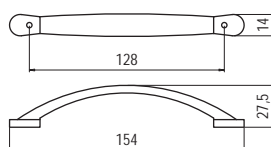

szín	cikkszám
1. matt alumínium	00007550060
2. króm	00007550061
3. nikkel	00007550062
4. antikolt	00007550063



## 132-96 - fém

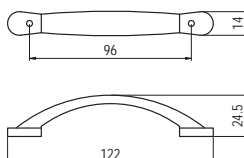

szín	cikkszám
1. matt alumínium	00007550070
2. króm	00007550071
3. nikkel	00007550072
4. antikolt	00007550073

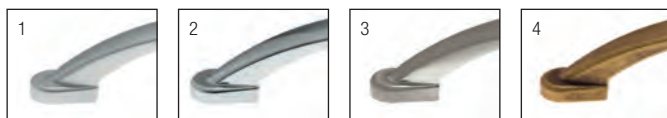

## 132-64 - fém

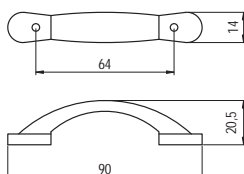

szín	cikkszám
1. matt alumínium	00007550080
2. króm	00007550081
3. nikkel	00007550082
4. antikolt	00007550083

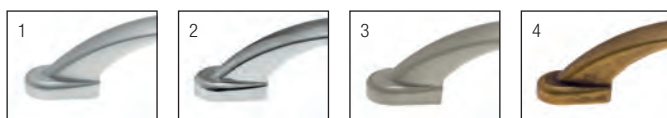

## 4.48 • Bútorfogantyúk

### E058-042 - fém

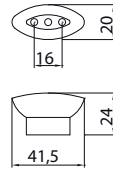

szín	cikkszám
1. króm	00007652140
2. inox	00007652141

### E057-160 - fém

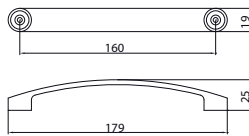
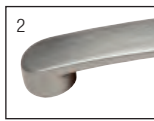

szín	cikkszám
1. króm	00007652130
2. inox	00007652131

### E056-160 - fém

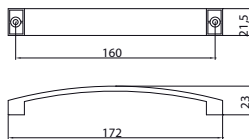

szín	cikkszám
1. króm	00007652120
2. inox	00007652121

### E054-192 - fém

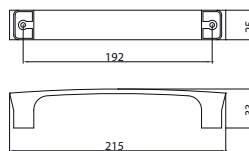

szín	cikkszám
1. inox	00007652100
2. nikkel	00007652101
3. króm	00007652102

### E055-034 - fém



szín	cikkszám
1. inox	00007652110
2. nikkel	00007652111
3. króm	00007652112



## 1313-130 - fém

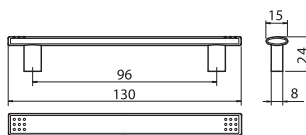

szín	cikkszám
1. króm	00007411550
2. matt króm	00007411551
3. matt nikkel	00007411552



## 1314-20 - fém



szín	cikkszám
1. króm	00007411560
2. matt króm	00007411561
3. matt nikkel	00007411562

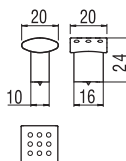

## 1309-116 - fém

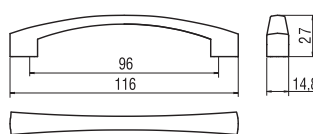

szín	cikkszám
matt nikkel	00007411572

## 1253-180 - fém

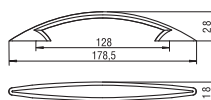

szín	cikkszám
1. króm	00007304140
2. matt nikkel	00007304141
3. réz	00007304142
4. alumínium	00007304143

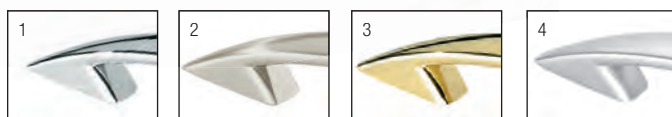

## 4.50 • Bútorfogantyúk

### 873-28 - fém

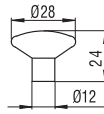

szín	cikkszám
1. króm	00007410600
2. fekete nikkel	00007410700
3. matt króm	00007410800
4. matt nikkel	00007410900
5. réz	00007411000

### 878-128 - fém

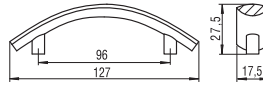

szín	cikkszám
1. króm	00007411100
2. fekete nikkel	00007411200
3. matt króm	00007411300
4. matt nikkel	00007411400
5. réz	00007411500

### 878-160 - fém

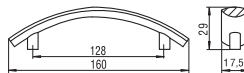

szín	cikkszám
1. króm	00007411510
2. matt króm	00007411520
3. matt nikkel	00007411530



## 923-101 - fém

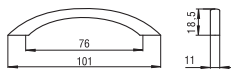

szín	cikkszám
1. króm	<b>00007415600</b>
2. réz	<b>00007415700</b>

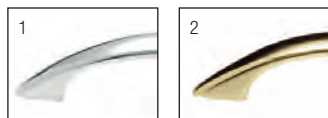

## 932-16 - fém

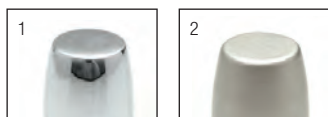
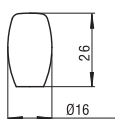
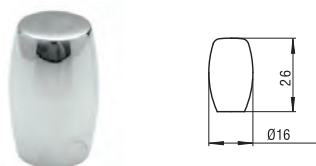

szín	cikkszám
1. króm	<b>00007416400</b>
2. matt nikkell	<b>00007416600</b>



## 912-73 - fém

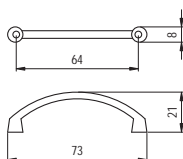

szín	cikkszám
1. króm	<b>00007412600</b>
2. réz	<b>00007412700</b>

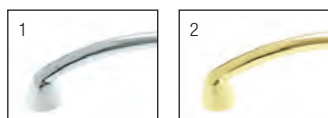

## 941-107 - fém

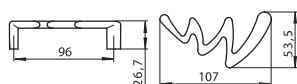

szín	cikkszám
króm	<b>00007416720</b>

## 4.52 • Bútorfogantyúk

### ■ MT 1317-26 - fém

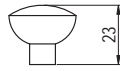
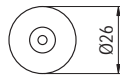

szín	cikkszám
1. krom	00007255010
2. matt krom	00007255013
3. matt nikkel	00007255015

### ■ MT 1318-121 - fém

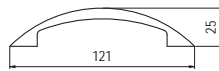
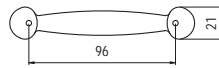
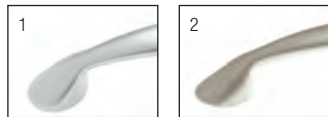

szín	cikkszám
1. matt krom	00007255019
2. matt nikkel	00007255021

### ■ MT 1319-94 - fém

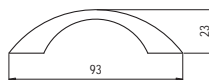
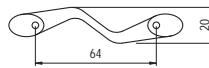

szín	cikkszám
1. krom	00007255023
2. matt krom	00007255025
3. matt nikkel	00007255027

### ■ MT 1301-82 - fém

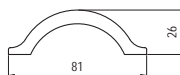
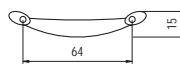

szín	cikkszám
1. krom	00007255029
2. matt krom	00007255031
3. matt nikkel	00007255033

## 1029-147 - fém

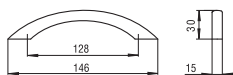

szín	cikkszám
1. matt króm	00007300052
2. matt nikkel	00007300056

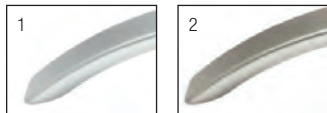

## 908-110 - fém

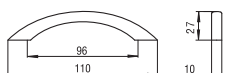

szín	cikkszám
1. króm	00007411600
2. fekete nikkel	00007411700
3. réz	00007411800



## 911-72 - fém

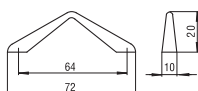

szín	cikkszám
1. króm	00007412300
2. fekete nikkel	00007412400
3. réz	00007412500



## 914-102 - fém

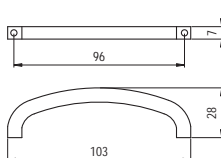

szín	cikkszám
1. króm	00007413000
2. fekete nikkel	00007413100
3. réz	00007413200



## 916-135 - fém

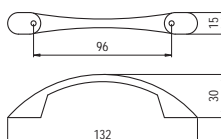

szín	cikkszám
1. fekete nikkel	00007413700
2. matt nikkel	00007413805

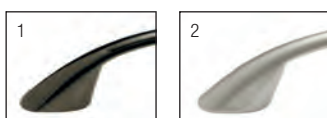



## 4.54 • Bútorfogantyúk

### T 250-96 - fém

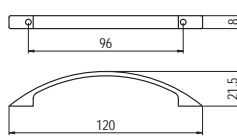
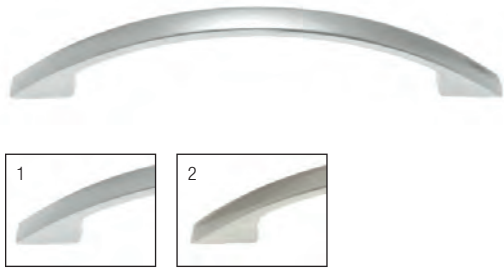

szín	cikkszám
1. matt króm	00007601375
2. matt nikkel	00007601376

### T 250-128 - fém

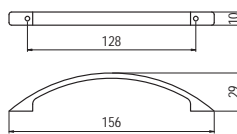
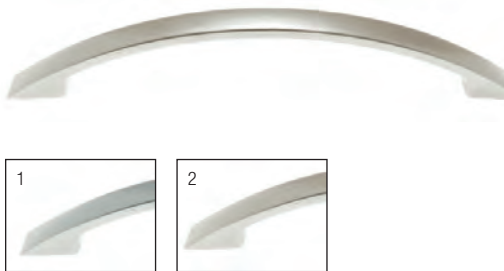

szín	cikkszám
1. matt króm	00007601379
2. matt nikkel	00007601380

### T 252-28 - fém

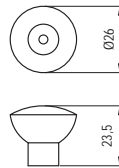

szín	cikkszám
1. króm	00007601389
2. matt króm	00007601390
3. matt nikkel	00007601393

### T 253-96 - fém

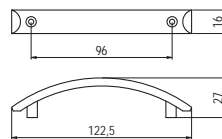
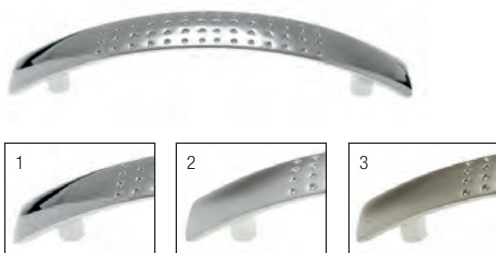

szín	cikkszám
1. króm	00007601396
2. matt króm	00007601397
3. matt nikkel	00007601398



### T 255-128 - fém

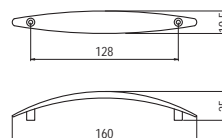
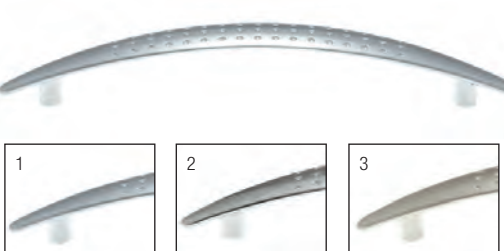

szín	cikkszám
1. matt króm	00007610010
2. króm	00007610011
3. matt nikkel	00007610012



## T 232-96 - fém

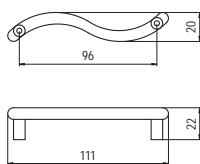
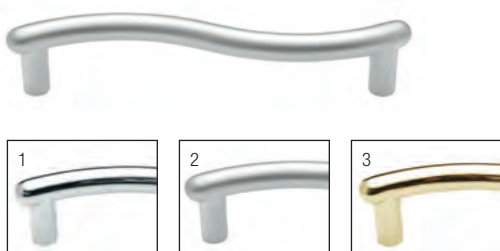

szín	cikkszám
1. króm	00007606429
2. matt króm	00007606430
3. réz	00007606431

## T 232-128 - fém

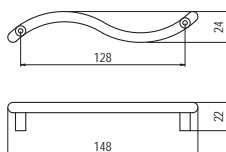
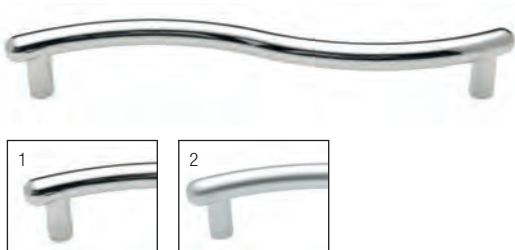

szín	cikkszám
1. króm	00007606432
2. matt króm	00007606433

## T 257-96 - fém

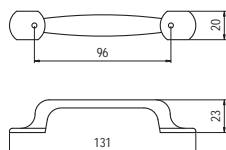
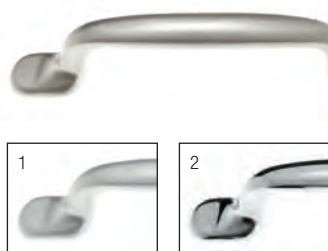

szín	cikkszám
1. matt króm	00007610030
2. króm	00007610031

## G 985-128 - fém

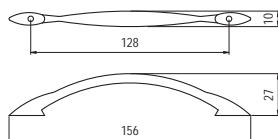
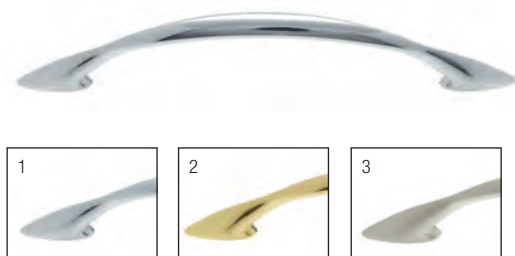

szín	cikkszám
1. króm	00008105700
2. réz	00008105800
3. nikkel	00008105900

## T 204-96 - fém

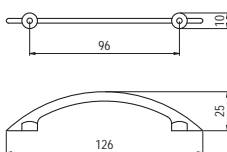
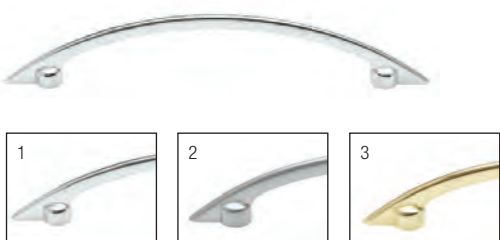

szín	cikkszám
1. króm	00007602300
2. matt acél	00007602400
3. réz	00007602500

## 4.56 • Bútorfogantyúk

### T 243-96 - fém

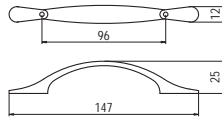

szín	cikkszám
1. króm	00007601333
2. matt króm	00007601334
3. matt nikkel	00007601335

### T 236-128 - fém

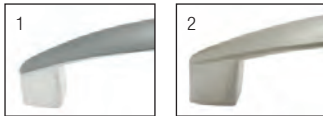
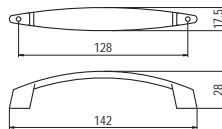

szín	cikkszám
1. matt króm	00007606470
2. nikkel	00007606472

### T 238-96 - fém

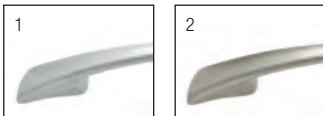
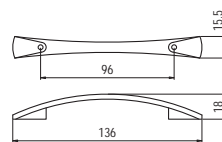

szín	cikkszám
1. matt króm	00007606484
2. matt nikkel	00007606485

### G 955-96 - fém

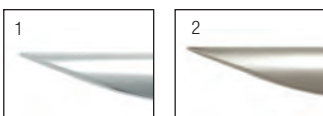
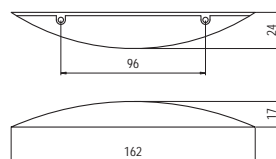

szín	cikkszám
1. króm	00008106000
2. matt nikkel	00008106020

## T 244-64 - fém

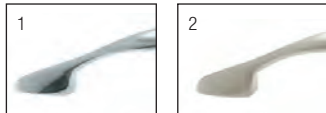
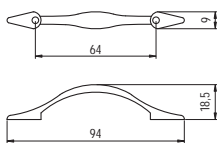

szín	cikkszám
1. króm	00007601339
2. matt nikkel	00007601340

## T 244-96 - fém

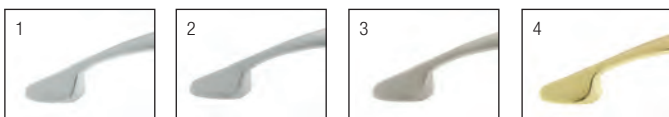
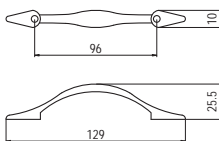

szín	cikkszám
1. króm	00007601343
2. matt króm	00007601344
3. matt nikkel	00007601345
4. réz	00007601346



## T 256-96 - fém

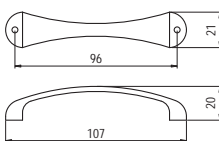

szín	cikkszám
matt króm	00007610021

## T 258-96 - fém

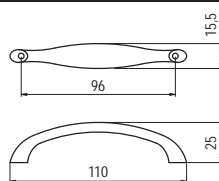

szín	cikkszám
1. matt króm	00007610040
2. króm	00007610041
3. matt nikkel	00007610042

## T 259-64 - fém

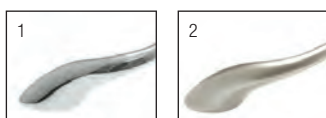
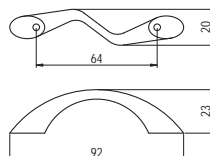

szín	cikkszám
1. króm	00007610051
2. matt nikkel	00007610052

## 4.58 • Bútorfogantyúk

### T 254-96 - fém

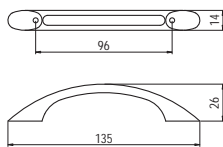

szín	cikkszám
1. antikolt	00007610000
2. matt fekete	00007610001
3. arany	00007610003
4. króm	00007610004
5. matt króm	00007610005
6. matt nikkel	00007610006

### T 241-96 - fém

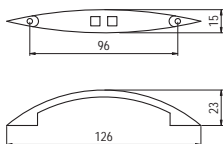
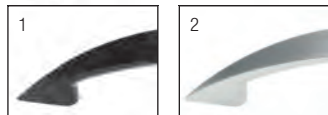

szín	cikkszám
1. matt fekete	00007601321
2. matt króm	00007601322

### T 223-96 - fém

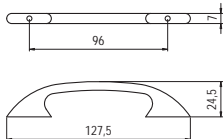
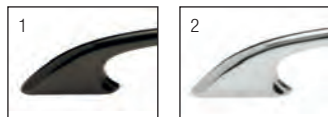

szín	cikkszám
1. fekete nikkel	00007605800
2. króm	00007605900

### T 233-96 - fém

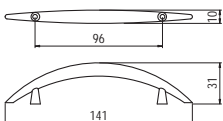

szín	cikkszám
1. króm	00007606435
2. réz	00007606436
3. matt nikkel	00007606437

### T 234-128 - fém

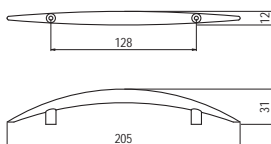
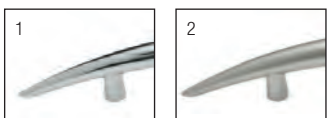

szín	cikkszám
1. króm	00007606438
2. matt nikkel	00007606440

## G 980-128 - fém



szín	cikkszám
1. króm	00008105500
2. nikkel	00008105600

## G 980-96 - fém



szín	cikkszám
1. réz	00008104900
2. króm	00008105000
3. nikkel	00008105100
4. fekete nikkel	00008105200
5. alumínium	00008105300

## G 972-96 - fém



szín	cikkszám
1. króm	00008104400
2. nikkel	00008104405

## G 1008-64 - fém



szín	cikkszám
króm	00008103600

## G 1008-96 - fém



szín	cikkszám
króm	00008103800

## G 1008-128 - fém



szín	cikkszám
króm	00008104000

## G 982-128 - fém



szín	cikkszám
matt nikkel	00008106120

## 4.60 • Bútorfogantyúk

### E003-096 - fém

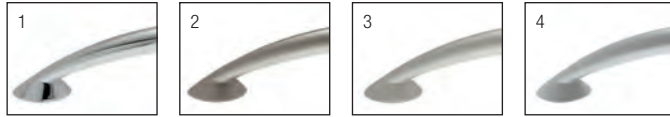
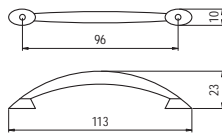

szín	cikkszám
1. króm	00007650400
2. nikkell	00007650401
3. matt nikkell	00007650402
4. matt króm	00007650403

### E002-064 - fém

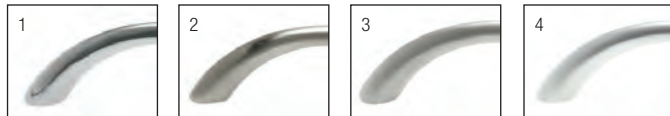
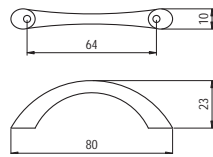

szín	cikkszám
1. króm	00007650370
2. nikkell	00007650371
3. matt nikkell	00007650372
4. matt króm	00007650373

### E018-096 - fém

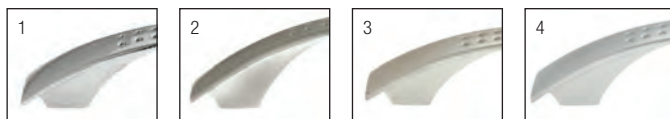
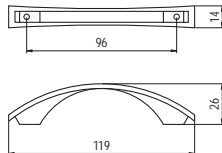

szín	cikkszám
1. króm	00007650640
2. nikkell	00007650641
3. matt nikkell	00007650642
4. matt króm	00007650643

### E018-128 - fém

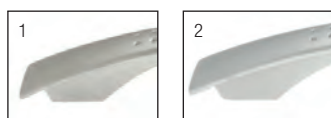
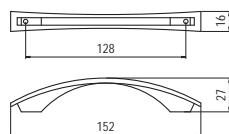

szín	cikkszám
1. matt nikkell	00007650652
2. matt króm	00007650653



## E002-096 - fém

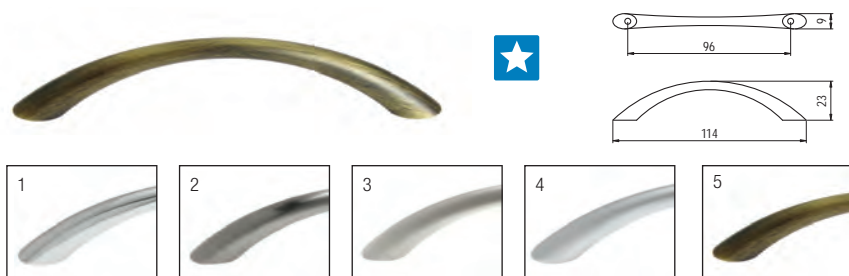

szín	cikkszám
1. króm	00007650380
2. nikkel	00007650381
3. matt nikkel	00007650382
4. matt króm	00007650383
5. antikolt	00007650384

## E002-128 - fém

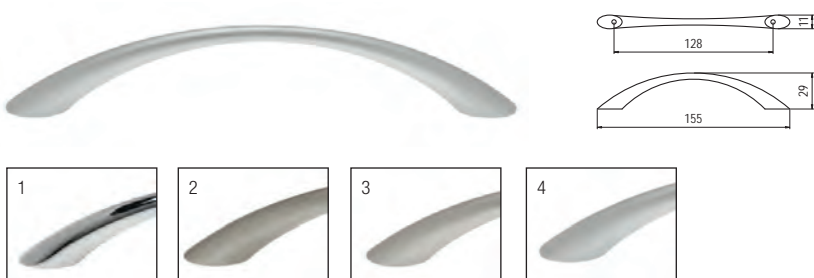

szín	cikkszám
1. króm	00007650390
2. nikkel	00007650391
3. matt nikkel	00007650392
4. matt króm	00007650393

## E005-096 - fém

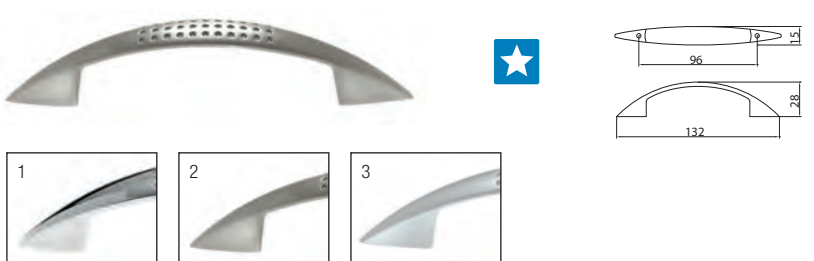

szín	cikkszám
1. króm	00007650420
2. nikkel	00007650421
3. matt króm	00007650423

## E005-128 - fém

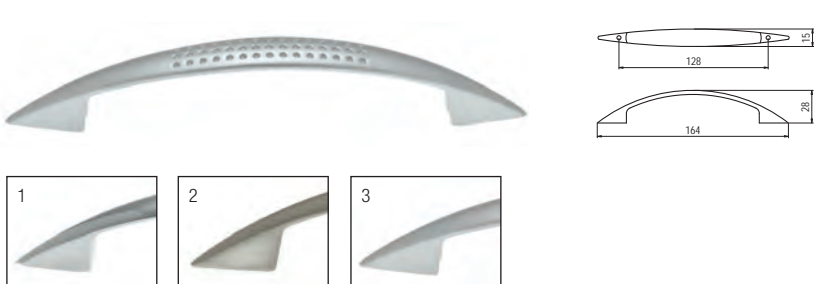

szín	cikkszám
1. króm	00007650430
2. nikkel	00007650431
3. matt króm	00007650433

## E004-096 - fém



szín	cikkszám
1. króm	00007650410
2. nikkel	00007650411
3. matt króm	00007650413
4. réz	00007650414
5. fekete	00007650415

## 4.62 • Bútorfogantyúk

### E006-128 - fém

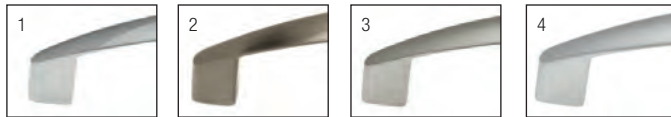
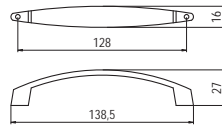

szín	cikkszám
1. króm	00007650450
2. nikkel	00007650451
3. matt nikkel	00007650452
4. matt króm	00007650453

### E008-096 - fém

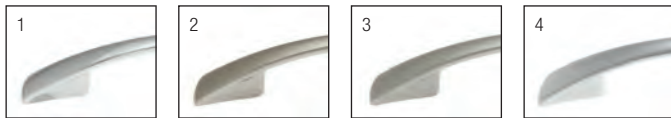
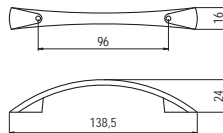

szín	cikkszám
1. króm	00007650480
2. nikkel	00007650481
3. matt nikkel	00007650482
4. matt króm	00007650483

### E008-128 - fém

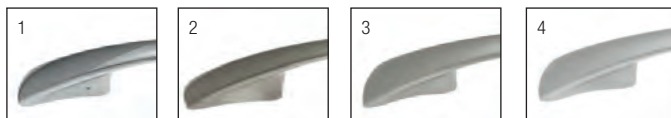
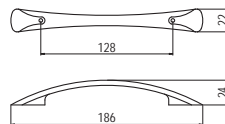

szín	cikkszám
1. króm	00007650490
2. nikkel	00007650491
3. matt nikkel	00007650492
4. matt króm	00007650493

### E011-128 - fém

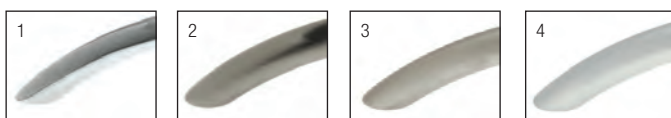
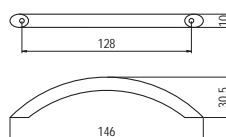

szín	cikkszám
1. króm	00007650540
2. nikkel	00007650541
3. matt nikkel	00007650542
4. matt króm	00007650543

## E013-032 - fém

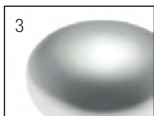

szín	cikkszám
1. króm	00007650560
2. nikkel	00007650561
3. matt króm	00007650563

## E014-096 - fém

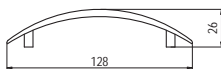
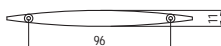

szín	cikkszám
1. króm	00007650570
2. nikkel	00007650571
3. matt nikkel	00007650572
4. matt króm	00007650573

## E019-096 - fém

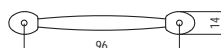

szín	cikkszám
1. króm	00007650660
2. nikkel	00007650661
3. matt nikkel	00007650662
4. matt króm	00007650663

## E019-128 - fém

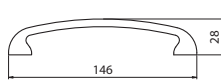

szín	cikkszám
1. króm	00007650670
2. nikkel	00007650671
3. matt nikkel	00007650672
4. matt króm	00007650673

## E015-064 - fém

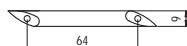

szín	cikkszám
1. króm	00007650580
2. nikkel	00007650581
3. matt nikkel	00007650582
4. matt króm	00007650583

## 4.64 • Bútorfogantyúk

### E015-096 - fém

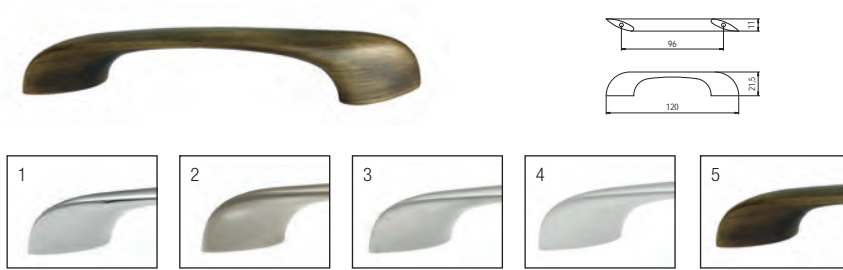

szín	cikkszám
1. króm	00007650590
2. nikkel	00007650591
3. matt nikkel	00007650592
4. matt króm	00007650593
5. antikolt	00007650594

### E015-128 - fém



szín	cikkszám
1. króm	00007650600
2. nikkel	00007650601
3. matt nikkel	00007650602
4. matt króm	00007650603

### E017-096 - fém

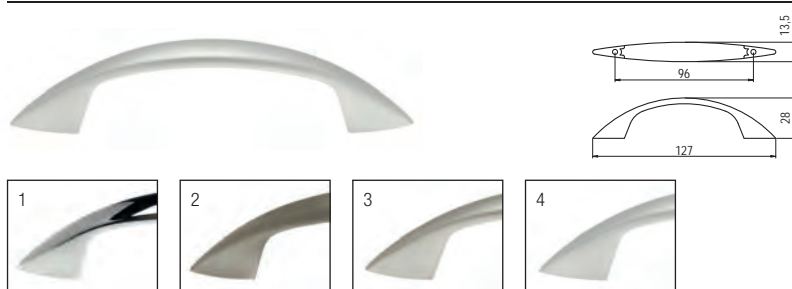

szín	cikkszám
1. króm	00007650620
2. nikkel	00007650621
3. matt nikkel	00007650622
4. matt króm	00007650623



### E018-064 - fém

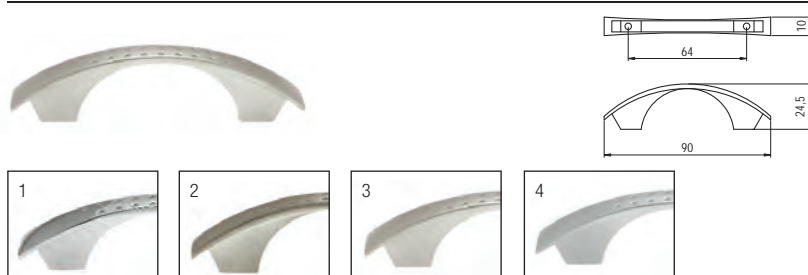

szín	cikkszám
1. króm	00007650630
2. nikkel	00007650631
3. matt nikkel	00007650632
4. matt króm	00007650633

## E033-096 - fém

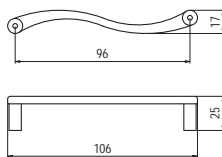

szín	cikkszám
1. króm	00007650830
2. matt nikkel	00007650832

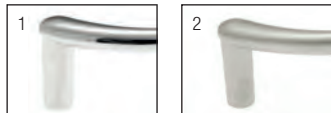

## E032-096 - fém

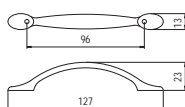

szín	cikkszám
1. króm	00007650810
2. nikkel	00007650811
3. matt króm	00007650813
4. antikolt	00007650814

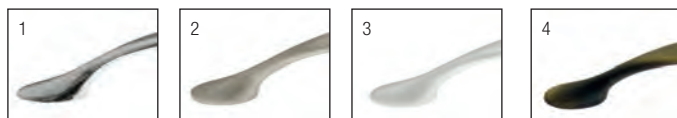

## E032-128 - fém

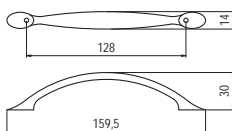

szín	cikkszám
1. króm	00007650820
2. nikkel	00007650821
3. matt króm	00007650823



## E062 - fém

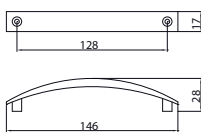

Hossz.	Furattáv.
146	128
178	160
210	192
274	256

szín	furattáv (mm)	cikkszám
króm	128	00007652220
	160	00007652230
	192	00007652240
	256	00007652250

## 4.66 • Bútorfogantyúk

### E059 - fém

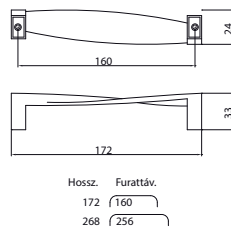

szín	furattáv (mm)	cikkszám
króm	160	00007652150
	256	00007652160

### E063 - fém

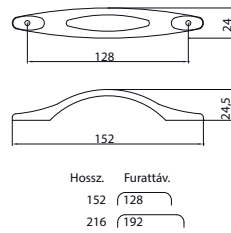

szín	furattáv (mm)	cikkszám
króm	128	00007652260
	192	00007652270

### E061 - fém

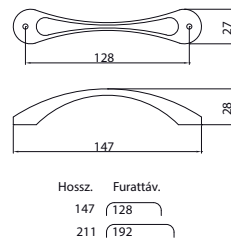

szín	furattáv (mm)	cikkszám
króm	128	00007652200
	192	00007652210

### E060 - fém

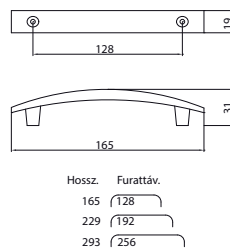

szín	furattáv (mm)	cikkszám
króm	128	00007652170
	192	00007652180
	256	00007652190





## BR-189 - fém

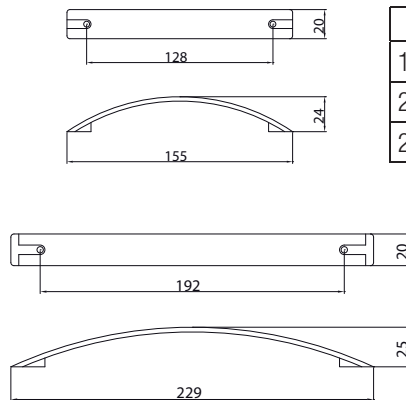
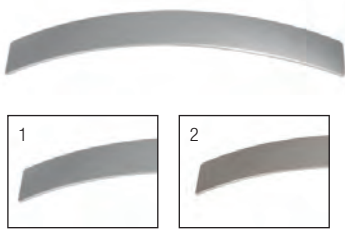

szín	furattáv (mm)	cikkszám
1. matt króm	128	00007700121
2. matt nikkel	128	00007700122
2. matt nikkel	192	00007700142

## BR-512 - fém

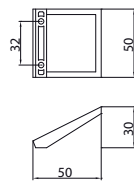

szín	cikkszám
1. matt króm	00007700181
2. krém	00007700182
3. sötétbarna	00007700183



## EM-053 - fém

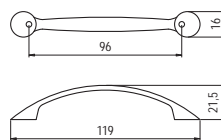
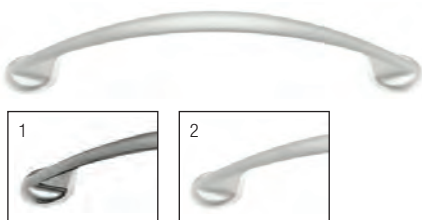

szín	cikkszám
1. króm	00007700010
2. matt króm	00007700011



## 4.68 • Bútorfogantyúk

### EM-022 - fém

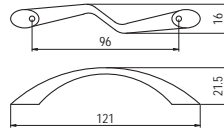
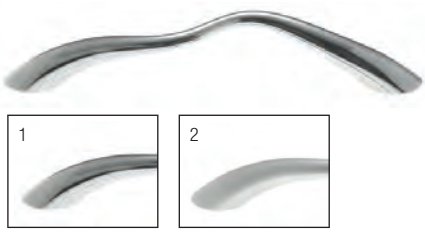

szín	cikkszám
1. króm	00007700020
2. matt króm	00007700021

### EM-093 - fém

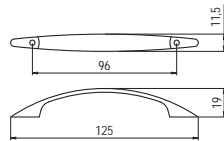
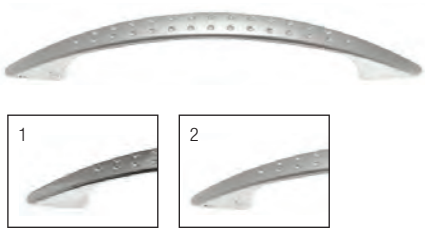

szín	cikkszám
1. króm	00007700030
2. matt króm	00007700031

### EM-011-E - fém

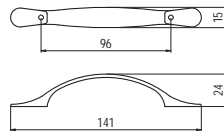
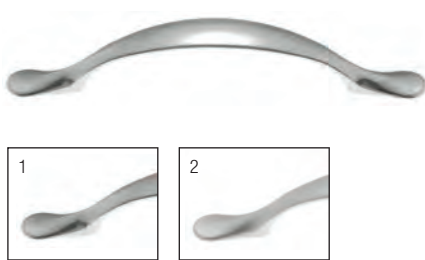

szín	cikkszám
1. króm	00007700040
2. matt króm	00007700041

### EM-013-D - fém

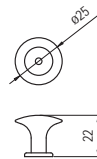

szín	cikkszám
1. króm	00007700050
2. matt króm	00007700051

### EM-054 - fém

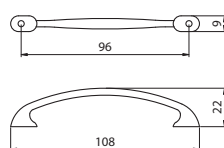
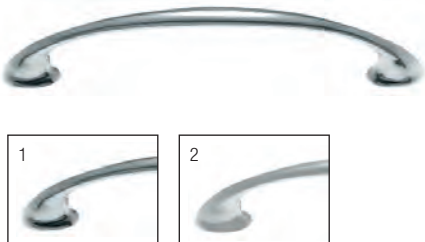

szín	cikkszám
1. króm	00007700000
2. matt króm	00007700001



■ 1340-134 - fém

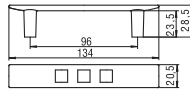

szín	cikkszám
matt króm - fekete	<b>00007304241</b>

■ 1342-134 - fém

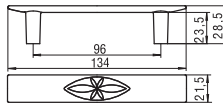

szín	cikkszám
matt króm - fekete	<b>00007304261</b>

■ 1095-90 - fém

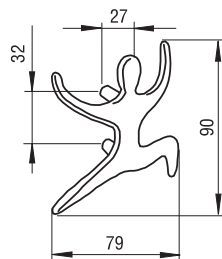

szín	cikkszám
1. króm	<b>00007300100</b>
2. matt króm	<b>00007300200</b>

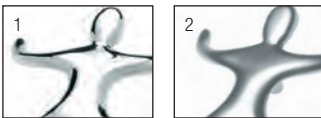

## 4.70 • Bútorfogantyúk

### T 306-26 - fém / műanyag

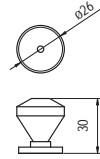

szín	cikkszám
acryl - króm	<b>00007607900</b>

### 913-32 - fém

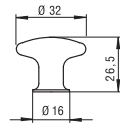
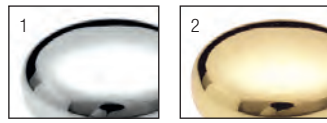

szín	cikkszám
1. króm	<b>00007412800</b>
2. réz	<b>00007412900</b>



### 919-30 - fém / műanyag

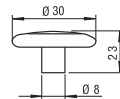
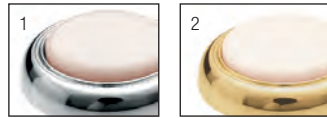

szín	cikkszám
1. króm - barack	<b>00007414500</b>
2. réz - barack	<b>00007414600</b>



### 918-38 - fém

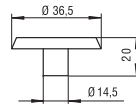
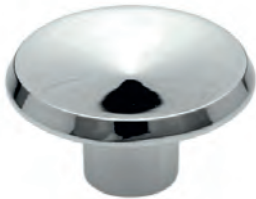

szín	cikkszám
króm	<b>00007414200</b>



### G 798-30 - fém

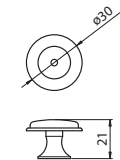

szín	cikkszám
1. réz	<b>00008102100</b>
2. króm	<b>00008102200</b>

### G 144-19 - fém



szín	cikkszám
króm	<b>00008100477</b>

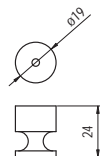

### G 143-25 - fém



szín	cikkszám
króm	<b>00008100462</b>

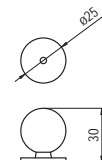



## 550.096 - fém / kristály

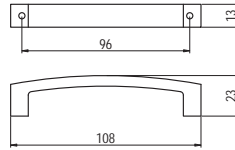

szín	cikkszám
1. matt alumínium - Swarovski kristály	00007552000
2. fekete nikkell - Swarovski zöld opál kristály	00007552001
3. fekete nikkell - Swarovski kristály	00007552002
4. arany - Swarovski smaragd kristály	00007552003

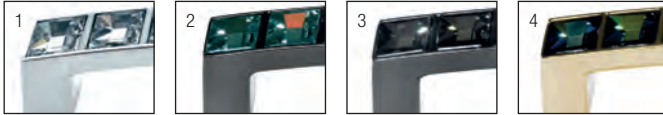

## 550.128 - fém / kristály

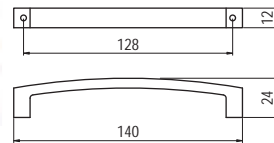

szín	cikkszám
króm - Swarovski kristály	00007552030

## 550.016 - fém / kristály

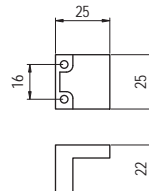

szín	cikkszám
1. matt alumínium - Swarovski kristály	00007552010
2. fekete nikkell - Swarovski zöld opál kristály	00007552011
3. fekete nikkell - Swarovski kristály	00007552012
4. arany - Swarovski smaragd kristály	00007552013

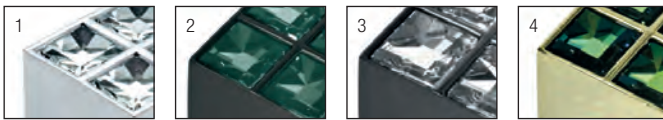

## 552.025 - fém / kristály



szín	cikkszám
króm - Swarovski kristály	00007552040

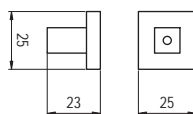

## 550.000 - fém / kristály



szín	cikkszám
króm - Swarovski kristály	00007552050

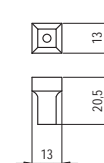

## 550.032 - fém / kristály

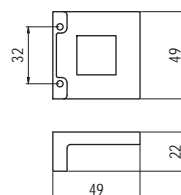

szín	cikkszám
1. fekete nikkell - Swarovski zöld opál kristály	00007552021
2. fekete nikkell - Swarovski kristály	00007552022
3. arany - Swarovski smaragd kristály	00007552023





## 4.72 • Bútorfogantyúk



■ **633.096** - fém / kristály

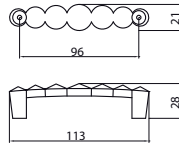

szín	cikkszám
1. króm - Swarovski kristály	<b>00007552140</b>
2. fekete - Swarovski kristály	<b>00007552141</b>
3. nikkell - Swarovski kristály	<b>00007552142</b>



■ **633.C32** - fém / kristály

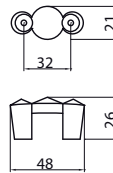

szín	cikkszám
1. fekete - Swarovski kristály	<b>00007552150</b>
2. nikkell - Swarovski kristály	<b>00007552151</b>
3. króm - Swarovski kristály	<b>00007552152</b>



■ **633.128** - fém / kristály

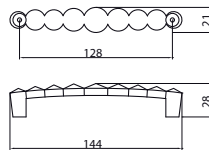

szín	cikkszám
1. króm - Swarovski kristály	<b>00007552160</b>
2. fekete - Swarovski kristály	<b>00007552161</b>
3. nikkell - Swarovski kristály	<b>00007552162</b>



■ **633.A64** - fém / kristály

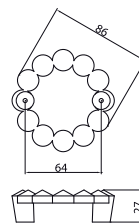

szín	cikkszám
króm - Swarovski kristály	<b>00007552170</b>

■ **633.B32** - fém / kristály

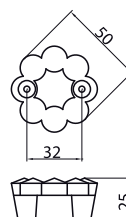

szín	cikkszám
1. króm - Swarovski kristály	<b>00007552180</b>
2. nikkell - Swarovski kristály	<b>00007552181</b>
3. fekete - Swarovski kristály	<b>00007552182</b>







633.017 - fém / kristály



szín	cikkszám
1. fekete - Swarovski kristály	00007552130
2. nikkel - Swarovski kristály	00007552131
3. króm - Swarovski kristály	00007552132



640.096 - fém / kristály

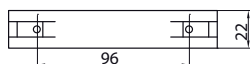

szín	cikkszám
1. fekete - Swarovski kristály	00007552191
2. nikkel - Swarovski kristály	00007552190

640.032 - fém / kristály

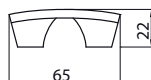
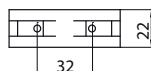
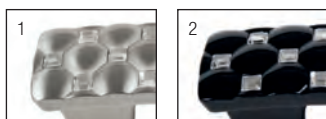

szín	cikkszám
1. nikkel - Swarovski kristály	00007552200
2. fekete - Swarovski kristály	00007552201

640.016 - fém / kristály

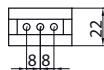

szín	cikkszám
1. fekete - Swarovski kristály	00007552210
2. nikkel - Swarovski kristály	00007552211

## 4.74 • Bútorfogantyúk



■ 693.015 - fém / kristály

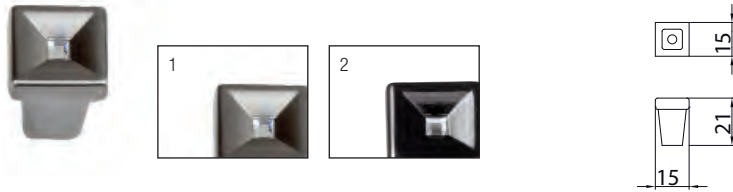

szín	cikkszám
1. nikkell - Swarovski kristály	<b>00007552280</b>
2. fekete - Swarovski kristály	<b>00007552281</b>

■ 693.031 - fém / kristály

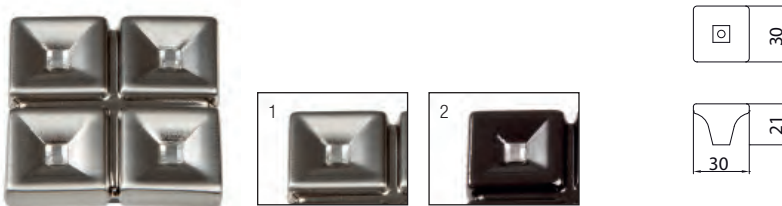

szín	cikkszám
1. nikkell - Swarovski kristály	<b>00007552290</b>
2. fekete - Swarovski kristály	<b>00007552291</b>

■ 693.032 - fém / kristály



szín	cikkszám
1. nikkell - Swarovski kristály	<b>00007552300</b>
2. fekete - Swarovski kristály	<b>00007552301</b>

■ 693.096 - fém / kristály



szín	cikkszám
1. nikkell - Swarovski kristály	<b>00007552310</b>
2. fekete - Swarovski kristály	<b>00007552311</b>

■ 693.128 - fém / kristály

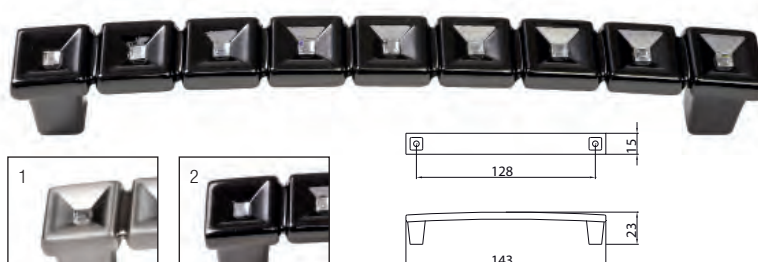

szín	cikkszám
1. nikkell - Swarovski kristály	<b>00007552320</b>
2. fekete - Swarovski kristály	<b>00007552321</b>



667.016 - fém / kristály

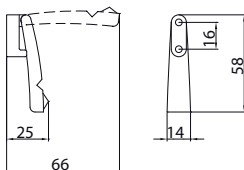

szín	cikkszám
1. nikkell - Swarovski kristály	00007552330
2. fekete - Swarovski kristály	00007552331



667.032 - fém / kristály

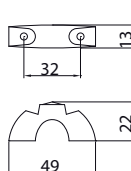

szín	cikkszám
1. nikkell - Swarovski kristály	00007552340
2. fekete - Swarovski kristály	00007552341



667.096 - fém / kristály

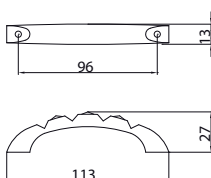

szín	cikkszám
1. nikkell - Swarovski kristály	00007552350
2. fekete - Swarovski kristály	00007552351

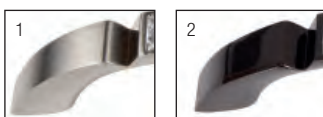

667.128 - fém / kristály



szín	cikkszám
1. nikkell - Swarovski kristály	00007552360
2. fekete - Swarovski kristály	00007552361

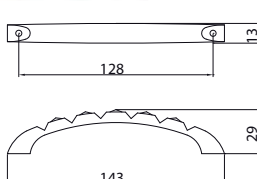
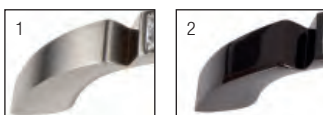

## 4.76 • Bútorfogantyúk



■ 694.000 - fém / kristály

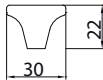

szín	cikkszám
1. nikkal - Swarovski kristály	<b>00007552240</b>
2. fekete - Swarovski kristály	<b>00007552241</b>

■ 694.096 - fém / kristály

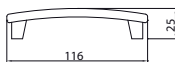
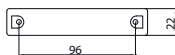

szín	cikkszám
1. nikkal - Swarovski kristály	<b>00007552250</b>
2. fekete - Swarovski kristály	<b>00007552251</b>



■ 694.128 - fém / kristály

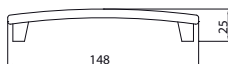

szín	cikkszám
1. nikkal - Swarovski kristály	<b>00007552260</b>
2. fekete - Swarovski kristály	<b>00007552261</b>



■ 694.160 - fém / kristály

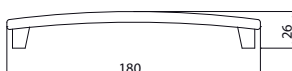
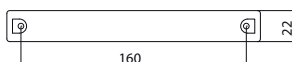

szín	cikkszám
1. nikkal - Swarovski kristály	<b>00007552270</b>
2. fekete - Swarovski kristály	<b>00007552271</b>







655.016 - fém / kristály

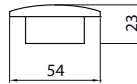
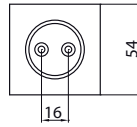

szín	cikkszám
1. króm - Swarovski kristály	00007552220
2. nikkell - Swarovski kristály	00007552221
3. antik - Swarovski kristály	00007552222

655.000 - fém / kristály

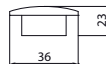
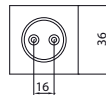

szín	cikkszám
1. króm - Swarovski kristály	00007552230
2. nikkell - Swarovski kristály	00007552231
3. antik - Swarovski kristály	00007552232



## 4.78 • Bútorfogantyúk



■ 550.096 - fém / csillám



szín	cikkszám
1. króm - csillám ezüst	00007552100
2. króm - csillám fekete	00007552101

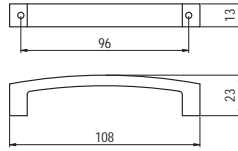

■ 550.016 - fém / csillám

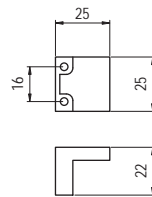
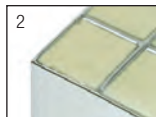
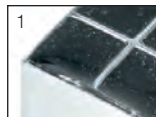

szín	cikkszám
1. króm - csillám fekete	00007552111
2. króm - elefántcsont	00007552112

■ 550.032 - fém / csillám

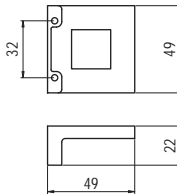
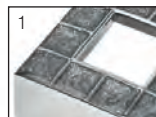
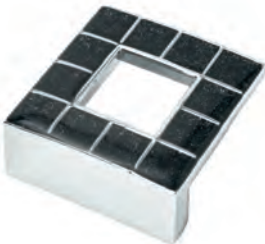

szín	cikkszám
1. króm - csillám ezüst	00007552120
2. króm - csillám fekete	00007552121

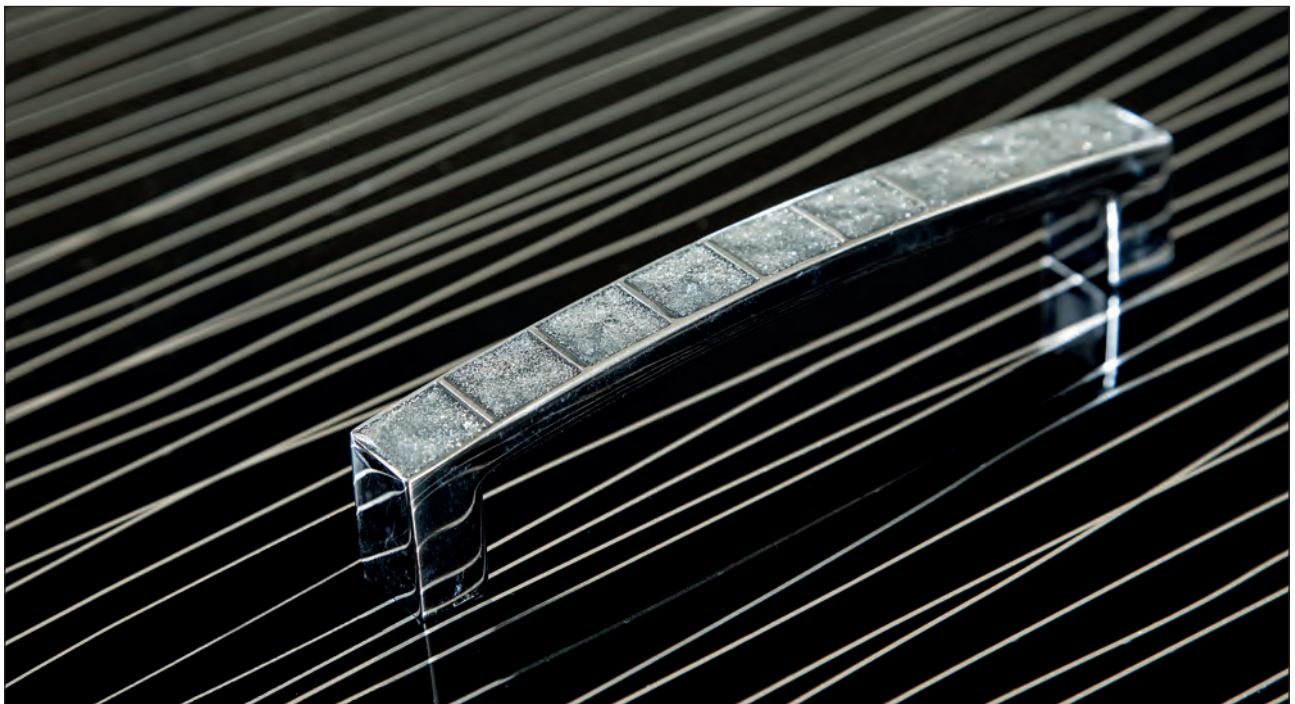



## 2032-36 - fém

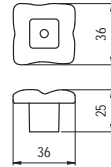

szín	cikkszám
1. antikolt ezüst	<b>00007306450</b>
2. antikolt réz	<b>00007306451</b>

## 2033-165 - fém

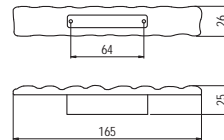
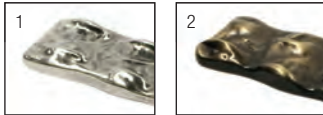

szín	cikkszám
1. antikolt ezüst	<b>00007306460</b>
2. antikolt réz	<b>00007306461</b>

## 2006-91 - fém

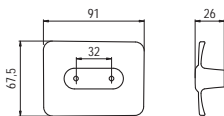
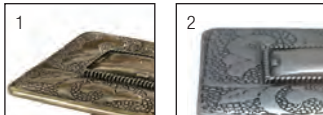

szín	cikkszám
1. antikolt	<b>00007306530</b>
2. antikolt ezüst	<b>00007306531</b>



## 4.80 • Bútorfogantyúk

■ 2015-54 - fém



szín	cikkszám
1. antik ezüst	00007306480
2. antikolt réz	00007306481



■ 1696-335 - fém

szín	cikkszám
antikolt	00007306500



■ 1697-376 - fém

szín	cikkszám
antikolt	00007306510

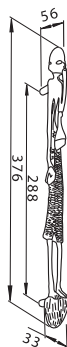

1874-365 - fém

szín	cikkszám
antikolt	00007306520

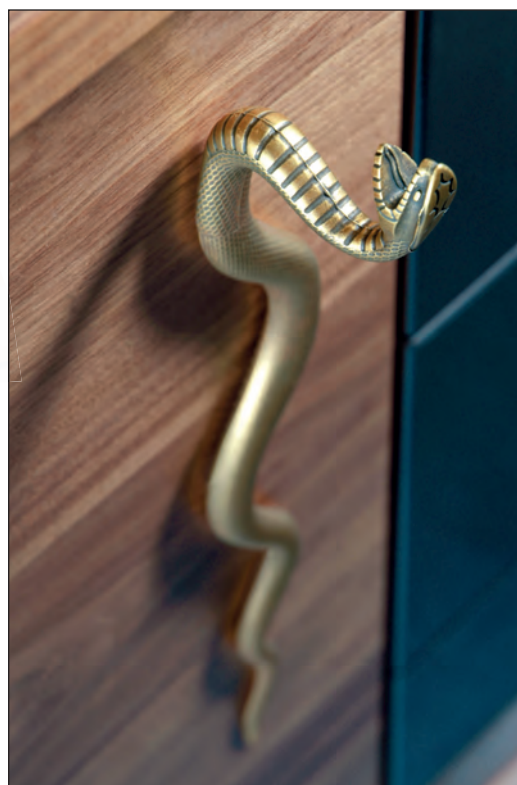
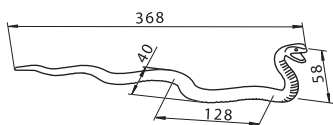

2076-24 - fém

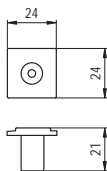
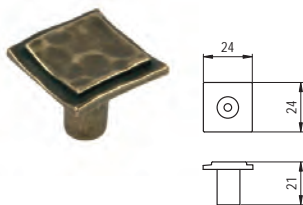

szín	cikkszám
antikolt	00007306560

2039-38 - fém

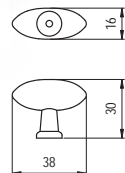
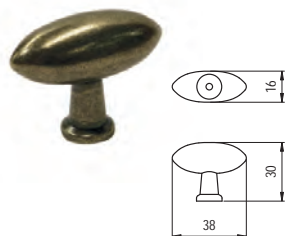

szín	cikkszám
antikolt	00007306590

2075-93 - fém

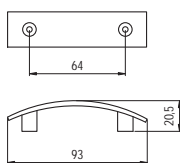

szín	cikkszám
antikolt	00007306561

2026-40 - fém

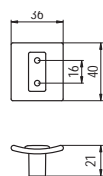

szín	cikkszám
1. króm	00007306570
2. antikolt	00007306571

## 4.82 • Bútorfogantyúk

### 1268-51 - fém

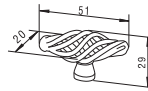

szín	cikkszám
1. antikolt	<b>00007304171</b>
2. matt fekete	<b>00007304172</b>

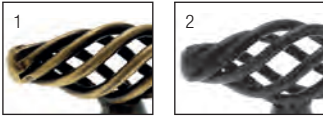

### 1268-62 - fém

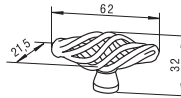

szín	cikkszám
1. antik ón	<b>00007304180</b>
2. antikolt	<b>00007304181</b>
3. matt fekete	<b>00007304182</b>



### 1303-34 - fém



szín	cikkszám
antikolt	<b>00007304191</b>

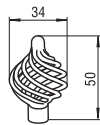

### 1304-104 - fém

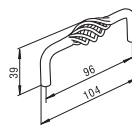

szín	cikkszám
1. antik ón	<b>00007304210</b>
2. antikolt	<b>00007304211</b>
3. matt fekete	<b>00007304212</b>



### 1304-136 - fém

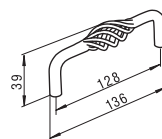

szín	cikkszám
2. antikolt	<b>00007304221</b>
3. matt fekete	<b>00007304222</b>

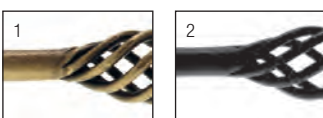



1209-30 - fém



szín	cikkszám
antikolt ezüst	00007303950

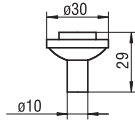

1209-40 - fém



szín	cikkszám
antikolt ezüst	00007303960

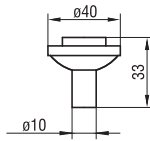

1368-33 - fém



szín	cikkszám
antikolt	00007304270

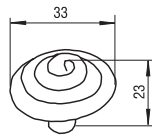

1368-42 - fém



szín	cikkszám
antikolt	00007304280

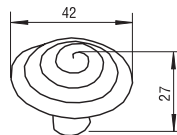

1210-106 - fém

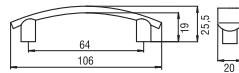

szín	cikkszám
antikolt ezüst	00007303970

1210-126 - fém

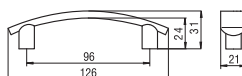

szín	cikkszám
antikolt ezüst	00007303980

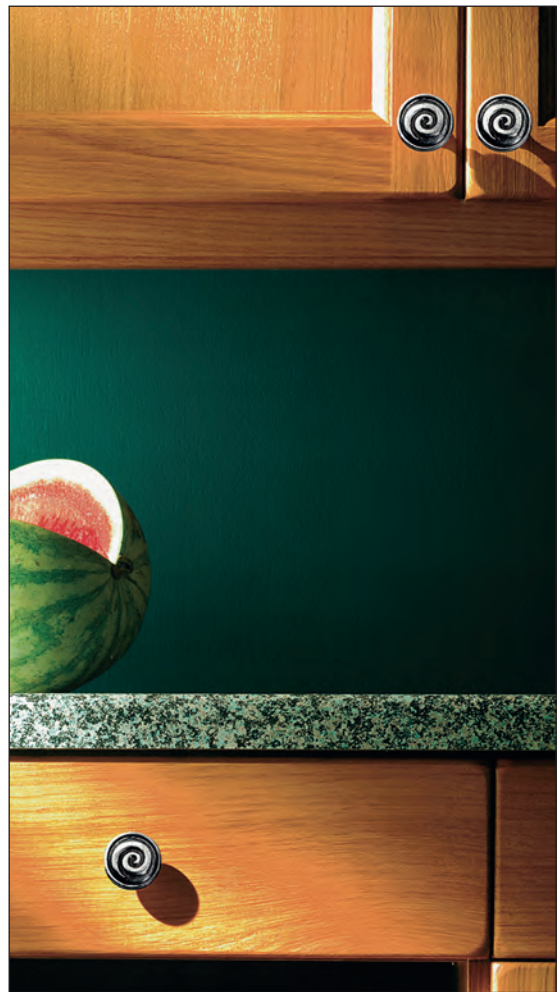

## 4.84 • Bútorfogantyúk



### 1021-146 - fém

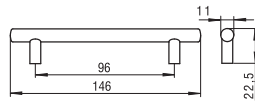

szín	cikkszám
1. antikolt	00007300028
2. matt nikkel	00007300036



### 479-106 - fém

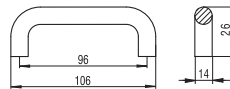

szín	cikkszám
antikolt	00007409650

### C2040 - fém

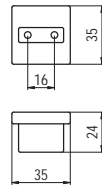
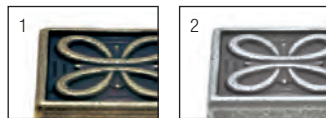

szín	cikkszám
1. matt bronz	00007500400
2. antik ezüst	00007500405

### C1020B - fém

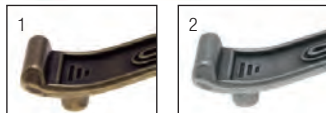
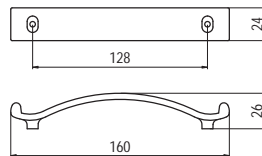

szín	cikkszám
1. matt bronz	00007500410
2. antik ezüst	00007500415

### C1020C - fém

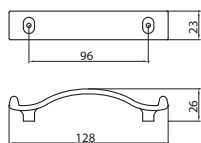

szín	cikkszám
1. matt bronz	00007500412
2. antik ezüst	00007500417

### 563-105 - fém

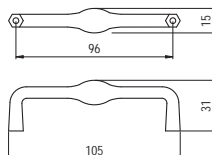

szín	cikkszám
antikolt	00007409672





## 1051-128 - fém

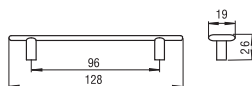

szín	cikkszám
1. antikolt	<b>00007418830</b>
2. antik ezüst	<b>00007418836</b>

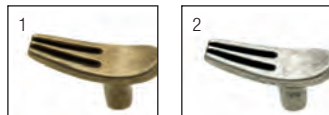

## 1052-126 - fém

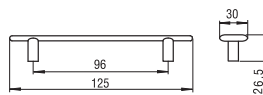

szín	cikkszám
1. antikolt	<b>00007418840</b>
2. antik réz	<b>00007418842</b>
3. antik ezüst	<b>00007418845</b>



## 1053-140 - fém

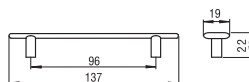

szín	cikkszám
1. antikolt	<b>00007418848</b>
2. antik réz	<b>00007418851</b>
3. antik ezüst	<b>00007418854</b>



## 1058-40 - fém

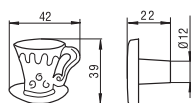

szín	cikkszám
1. antikolt	<b>00007418875</b>
2. antik réz	<b>00007418878</b>
3. antik ezüst	<b>00007418881</b>



## 4.86 • Bútorfogantyúk



### C2041C - fém

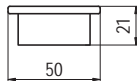
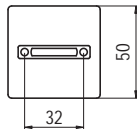

szín	cikkszám
1. matt bronz	00007500440
2. antik ezüst	00007500445
3. fekete	00007500450
4. fehér	00007500455

### C369B - fém



szín	cikkszám
1. antik ezüst	00007500710
2. matt bronz	00007500711
3. fényes fekete	00007500712
4. fényes fehér	00007500713

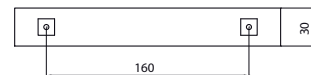

### C369C - fém

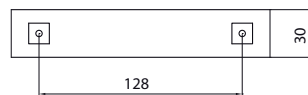

szín	cikkszám
1. antik ezüst	00007500720
2. matt bronz	00007500721
3. fényes fekete	00007500722
4. fényes fehér	00007500723

## 1197-110 - fém

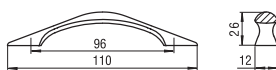
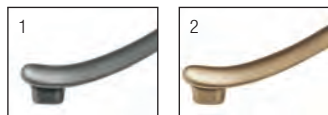

szín	cikkszám
1. kovácsoltvas	<b>00007306000</b>
2. antikolt	<b>00007306100</b>

## 1198-147 - fém

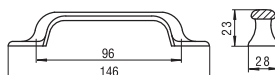
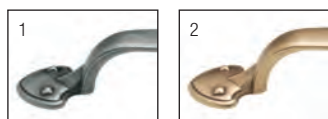

szín	cikkszám
1. kovácsoltvas	<b>00007306200</b>
2. antikolt	<b>00007306300</b>

## 920-28 - fém

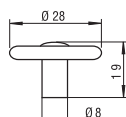

szín	cikkszám
1. króm	<b>00007414700</b>
2. antikolt	<b>00007414800</b>
3. réz	<b>00007414900</b>

## 921-127 - fém

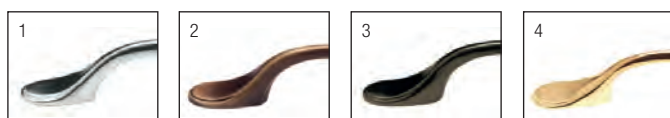
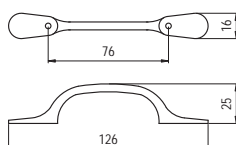

szín	cikkszám
1. króm	<b>00007415000</b>
2. antikolt	<b>00007415100</b>
3. fekete nikkelt	<b>00007415200</b>
4. réz	<b>00007415300</b>

## 4.88 • Bútorfogantyúk

### T 229-76 - fém

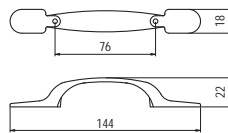

szín	cikkszám
antikolt	00007606422

### T 231-92 - fém

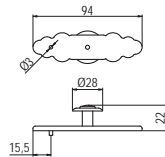

szín	cikkszám
antikolt	00007606428

### G 681/B-30 - fém

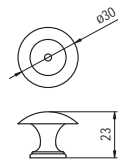

szín	cikkszám
1. réz	00008101000
2. króm	00008101100
3. antikolt	00008101200

### G 682-30 - fém

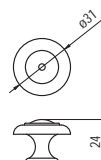

szín	cikkszám
1. antikolt	00008101244
2. bronz	00008101246



812-86 - fém

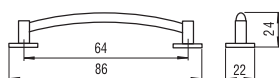

szín	cikkszám
antikolt	<b>00007410230</b>

812-120 - fém

szín	cikkszám
antikolt	<b>00007410235</b>

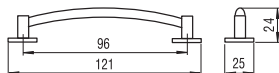

922-113 - fém

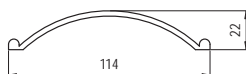
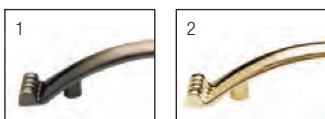
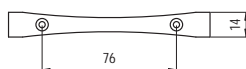

szín	cikkszám
1. antikolt	<b>00007415400</b>
2. réz	<b>00007415500</b>

924-108 - fém

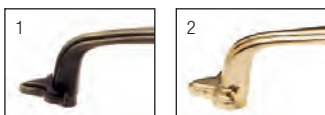
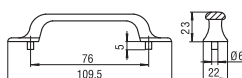

szín	cikkszám
1. antikolt	<b>00007415800</b>
2. réz	<b>00007415900</b>

## 4.90 • Bútorfogantyúk

### 356-97 - fém

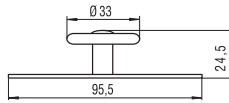

szín	cikkszám
antikolt	<b>00007409630</b>

### 495-112 - fém

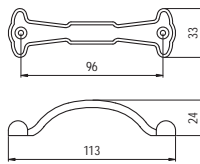

szín	cikkszám
antikolt	<b>00007409660</b>

### 947-102 - fém

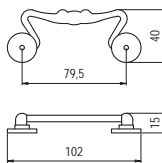

szín	cikkszám
antikolt	<b>00007416800</b>

### 947-86 - fém

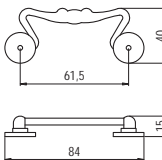

szín	cikkszám
1. antikolt	<b>00007417000</b>
2. fekete nikkel	<b>00007417100</b>



### 959-45 - fém

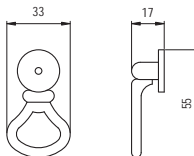

szín	cikkszám
1. antikolt	<b>00007418200</b>
2. réz	<b>00007418300</b>





## 397-23 - fém



szín	cikkszám
antikolt	<b>00007303651</b>

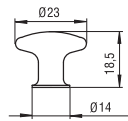

## 397-35 - fém



szín	cikkszám
antikolt	<b>00007303661</b>

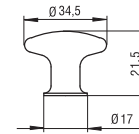

## 398-70 - fém

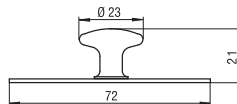

szín	cikkszám
antikolt	<b>00007303681</b>

## 398-98 - fém

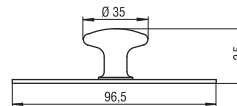

szín	cikkszám
antikolt	<b>00007303691</b>

## 1546-137 - fém

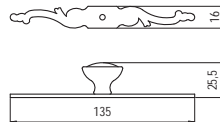

szín	cikkszám
1. antikolt	<b>00007304550</b>
2. antikolt ezüst	<b>00007304551</b>



## 4.92 • Bútorfogantyúk



### 1536-122 - fém

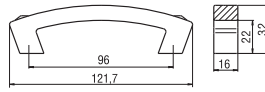

szín	cikkszám
antikolt	00007304490

### 1548-18 - fém

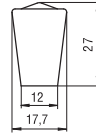

szín	cikkszám
antikolt	00007304560

### 1549-50 - fém

Alátét a 1548-18 fogantyúhoz

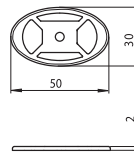

szín	cikkszám
antikolt	00007304570

### 1969-68 - fém

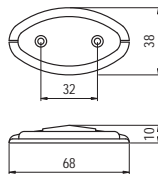

szín	cikkszám
antikolt réz	00007305010



### 1970-68 - fém

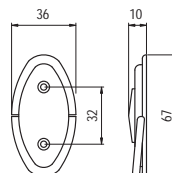

szín	cikkszám
antikolt réz	00007305020

### 1818-30 - fém

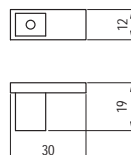

szín	cikkszám
antikolt réz	00007306380

## 1816-69 - fém

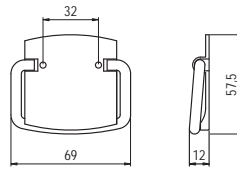

szín	cikkszám
1. nikkell	00007304925
2. antik réz	00007304926



## 1816-44 - fém

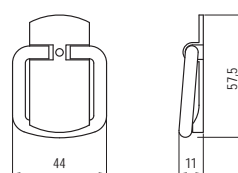

szín	cikkszám
1. nikkell	00007304920
2. antik réz	00007304921

## 4.94 • Bútorfogantyúk

### 1916-136 - fém

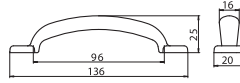

szín	cikkszám
antikolt ezüst	00007304960

### 1974-18 - fém

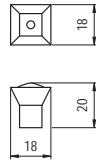

szín	cikkszám
antikolt réz	00007306410

### 969-46 - fém

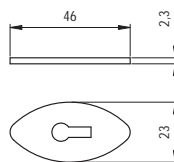

szín	cikkszám
1. antikolt	00007418700
2. réz	00007418800

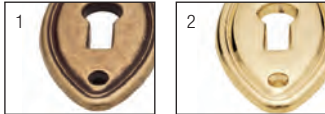

### 1986-44 - fém

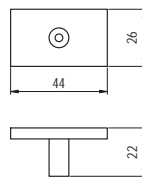

szín	cikkszám
1. antikolt ezüst	00007306350
2. antikolt réz	00007306351
3. króm	00007306352



### 1987-108 - fém

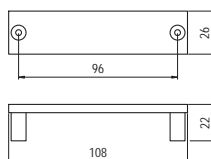

szín	cikkszám
króm	00007306362



## 1987-140 - fém

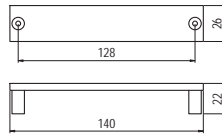

szín	cikkszám
1. antikolt ezüst	<b>00007306370</b>
2. antikolt réz	<b>00007306371</b>
3. króm	<b>00007306372</b>

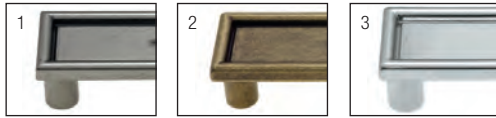

## 1984-30 - fém

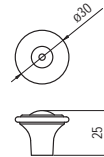

szín	cikkszám
antikolt réz	<b>00007306390</b>

## 1985-145 - fém

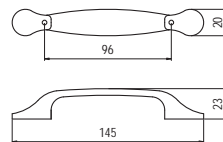

szín	cikkszám
antikolt réz	<b>00007306400</b>

## 2029-19 - fém



szín	cikkszám
antikolt	<b>00007305200</b>

## 2129-112 - fém

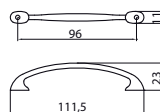

szín	cikkszám
antikolt	<b>00007306630</b>



## 4.96 • Bútorfogantyúk



### 602.030 - fém

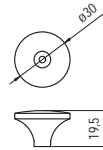

szín	cikkszám
antik Firenze	00007551250

### 614.D64 - fém

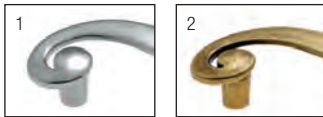
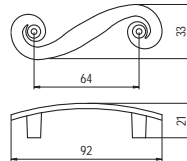

szín	cikkszám
1. króm	00007551410
2. antik Firenze	00007551420

### 614.S64 - fém

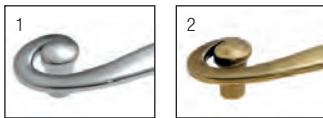
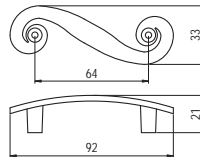

szín	cikkszám
1. króm	00007551415
2. antik Firenze	00007551425

### 614.D96 - fém

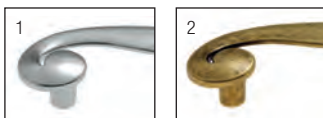
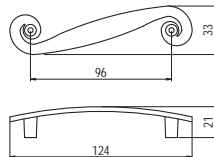

szín	cikkszám
1. króm	00007551411
2. antik Firenze	00007551421

### 614.S96 - fém

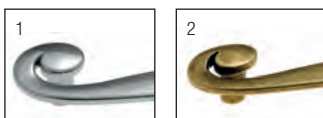
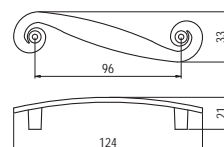

szín	cikkszám
1. króm	00007551416
2. antik Firenze	00007551426





## 610.096 - fém

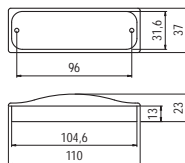

szín	cikkszám
antik Firenze	00007551380

## 2023/30 - fém



szín	cikkszám
antik Firenze	00007551450

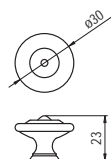

## 6017/0A - fém



szín	cikkszám
antik Firenze	00007551460

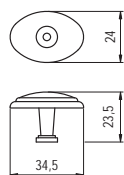

## 6022/30 - fém



szín	cikkszám
antik Firenze	00007551470

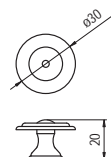

## 6200/32 - fém

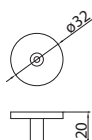

szín	cikkszám
1. antik Firenze	00007551480
2. króm	00007551481



## 4.98 • Bútorfogantyúk



■ 604.096 - fém

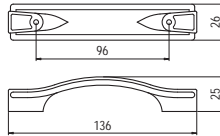

szín	cikkszám
antik Firenze	<b>00007551281</b>

■ 604.128 - fém

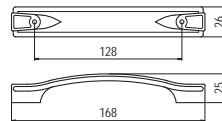

szín	cikkszám
antik Firenze	<b>00007551282</b>

■ 611.032 - fém

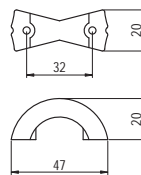

szín	cikkszám
antik Firenze	<b>00007551400</b>

■ 611.096 - fém

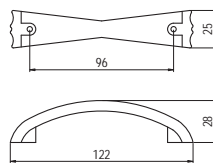

szín	cikkszám
antik Firenze	<b>00007551401</b>

■ 611.128 - fém

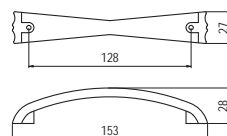

szín	cikkszám
antik Firenze	<b>00007551402</b>



552.096 - fém

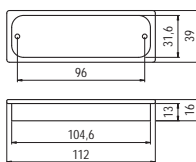

szín	cikkszám
antik Firenze	00007551230

552.128 - fém

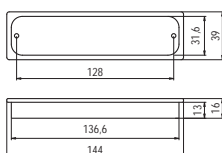

szín	cikkszám
antik Firenze	00007551231

603.096 - fém

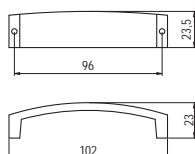

szín	cikkszám
antik Firenze	00007551261

603.128 - fém

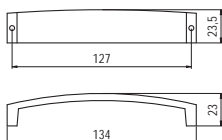

szín	cikkszám
antik Firenze	00007551262

2025-25 - fém

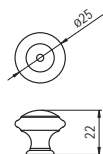

szín	cikkszám
1. antikolt	00007550500
2. nikkel	00007550501

2025-35 - fém

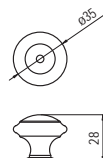
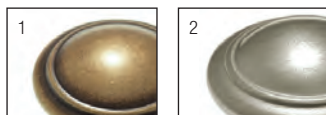

szín	cikkszám
1. antikolt	00007550510
2. nikkel	00007550511

## 4.100 • Bútorfogantyúk



■ 5059 - fém

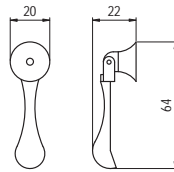

szín	cikkszám
antikolt	<b>00007550530</b>

■ 5042/A - fém

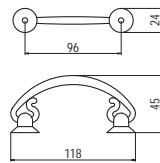

szín	cikkszám
antikolt	<b>00007550540</b>

■ 5042/B - fém

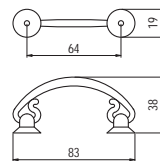

szín	cikkszám
antikolt	<b>00007550550</b>

■ 5021/A - fém

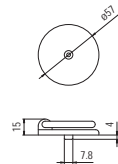

szín	cikkszám
antikolt	<b>00007550520</b>

■ 5031/B - fém

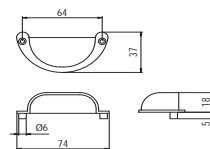

szín	cikkszám
antikolt	<b>00007550580</b>

■ 5031/A - fém

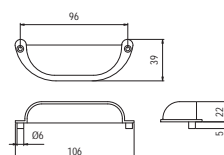

szín	cikkszám
antikolt	<b>00007550590</b>



■ 222-96 - fém

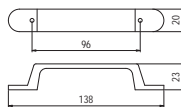

szín	cikkszám
antikolt bronz	<b>00007550800</b>

■ 222-32 - fém

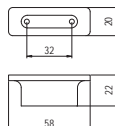

szín	cikkszám
antikolt bronz	<b>00007550810</b>

■ 232-96 - fém

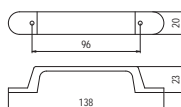

szín	cikkszám
antikolt bronz	<b>00007550860</b>

■ 232-32 - fém

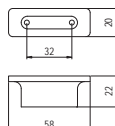

szín	cikkszám
antikolt bronz	<b>00007550870</b>

■ 5091 - fém

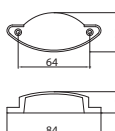

szín	cikkszám
antikolt	<b>00007550560</b>

■ 516-96 - fém

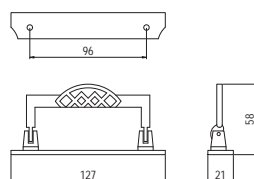

szín	cikkszám
antikolt bronz	<b>00007550880</b>

■ 514-96 - fém

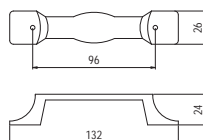

szín	cikkszám
antikolt bronz	<b>00007550890</b>

■ 514-000 - fém

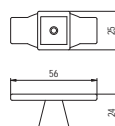

szín	cikkszám
antikolt bronz	<b>00007550900</b>

## 4.102 • Bútorfogantyúk



■ 515-96 - fém

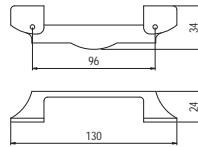

szín	cikkszám
antikolt bronz	<b>00007550910</b>

■ 515-000 - fém

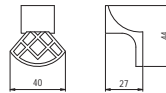

szín	cikkszám
antikolt bronz	<b>00007550920</b>

■ 7115/42 - fém

díszítő elem

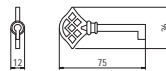

szín	cikkszám
antikolt bronz	<b>00007550930</b>

■ 518-000 - fém

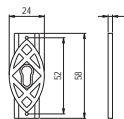

szín	cikkszám
antikolt bronz	<b>00007550940</b>

■ 214-96 - fém

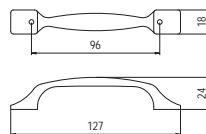

szín	cikkszám
antikolt bronz	<b>00007550680</b>

■ 224-96 - fém

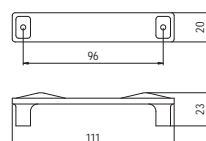

szín	cikkszám
1. antikolt bronz	<b>00007550720</b>
2. nikkel	<b>00007550721</b>

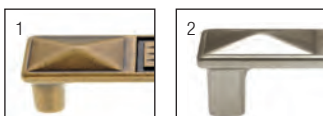





## 224-16 - fém

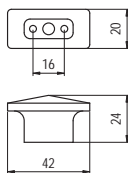

szín	cikkszám
1. antikolt bronz	<b>00007550730</b>
2. nikkel	<b>00007550731</b>

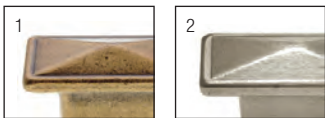

## 231-96 - fém

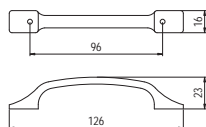

szín	cikkszám
1. antikolt bronz	<b>00007550750</b>
2. nikkel	<b>00007550751</b>

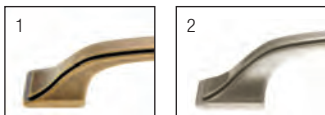

## 231-128 - fém

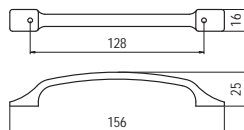

szín	cikkszám
nikkel	<b>00007550755</b>

## 225-96 - fém

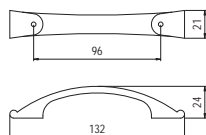

szín	cikkszám
antikolt bronz	<b>00007550640</b>

## 225-16 - fém

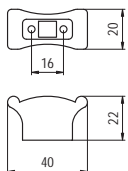

szín	cikkszám
antikolt bronz	<b>00007550650</b>

## 226-96 - fém

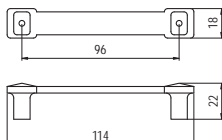

szín	cikkszám
antikolt bronz	<b>00007550700</b>

## 4.104 • Bútorfogantyúk



■ 226-24 - fém

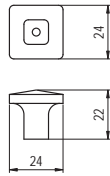

szín	cikkszám
antikolt bronz	<b>00007550710</b>

■ 218-96 - fém

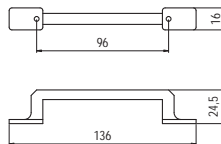

szín	cikkszám
antikolt bronz	<b>00007550760</b>

■ 114-000 - fém

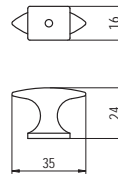

szín	cikkszám
antikolt bronz	<b>00007550690</b>

■ 228-96 - fém

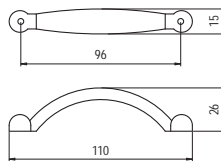

szín	cikkszám
antikolt bronz	<b>00007550740</b>

■ 118-000 - fém

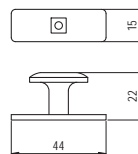

szín	cikkszám
antikolt bronz	<b>00007550770</b>

■ 215-96 - fém

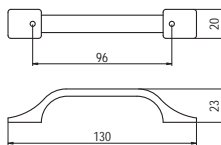

szín	cikkszám
antikolt bronz	<b>00007550840</b>

■ 115-000 - fém

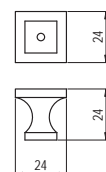

szín	cikkszám
1. antikolt bronz	<b>00007550850</b>
2. nikkel	<b>00007550851</b>





## 503-96 - fém

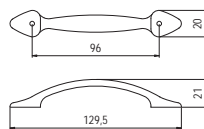

szín	cikkszám
1. antikolt bronz	<b>00007550620</b>
2. antikolt ezüst	<b>00007550621</b>

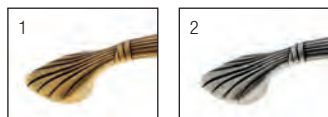

## 503-000 - fém

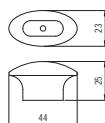

szín	cikkszám
1. antikolt bronz	<b>00007550630</b>
2. antikolt ezüst	<b>00007550631</b>



## 501-96 - fém

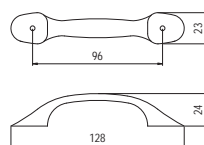

szín	cikkszám
1. antikolt bronz	<b>00007550820</b>
2. antikolt ezüst	<b>00007550821</b>

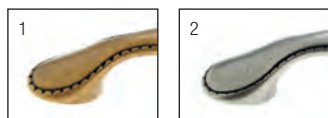

## 501-000 - fém

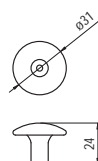

szín	cikkszám
1. antikolt bronz	<b>00007550830</b>
2. antikolt ezüst	<b>00007550831</b>

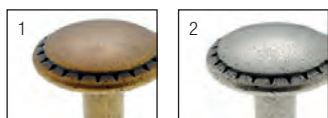

## 216-96 - fém

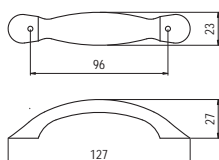

szín	cikkszám
antik Firenze	<b>00007550970</b>

## 4.106 • Bútorfogantyúk



■ 504-96 - fém

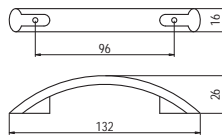

szín	cikkszám
antikolt bronz	<b>00007550600</b>

■ 504-32 - fém

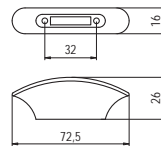

szín	cikkszám
antikolt bronz	<b>00007550610</b>

■ 229-96 - fém

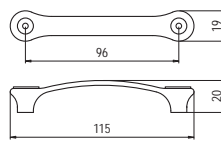

szín	cikkszám
antikolt bronz	<b>00007550780</b>

■ 229-30 - fém

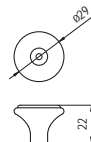

szín	cikkszám
antikolt bronz	<b>00007550790</b>

■ 221-96 - fém

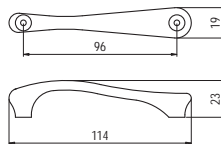

szín	cikkszám
antik Firenze	<b>00007550950</b>

■ 221-64 - fém

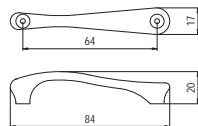

szín	cikkszám
antik Firenze	<b>00007550960</b>

■ 133-96 - fém

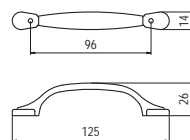

szín	cikkszám
antik Firenze	<b>00007551000</b>

■ 133-128 - fém

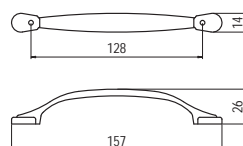

szín	cikkszám
antik Firenze	<b>00007551010</b>



## 533-96 - fém

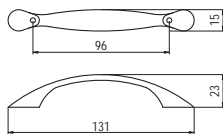

szín	cikkszám
antik Firenze	<b>00007550980</b>

## 533-128 - fém

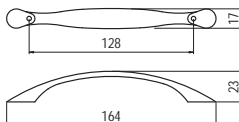

szín	cikkszám
antik Firenze	<b>00007550990</b>

## 532-128 - fém

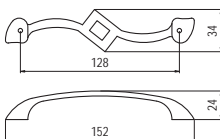

szín	cikkszám
1. antik Firenze	<b>00007551100</b>
2. nikkel	<b>00007551101</b>

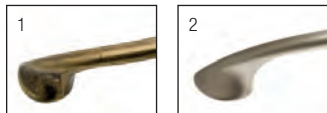

## 532-96 - fém

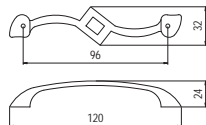

szín	cikkszám
1. antik Firenze	<b>00007551110</b>
2. nikkel	<b>00007551111</b>



## 534-96 - fém

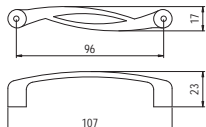

szín	cikkszám
1. antik Firenze	<b>00007551120</b>
2. nikkel	<b>00007551121</b>

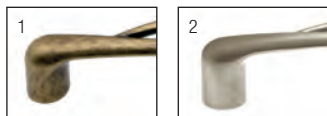

## 534-128 - fém

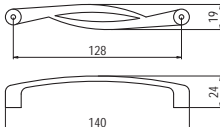

szín	cikkszám
1. antik Firenze	<b>00007551130</b>
2. nikkel	<b>00007551131</b>

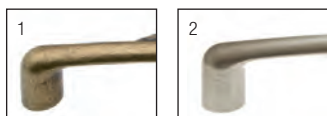

## 4.108 • Bútorfogantyúk



■ 545-000 - fém



szín	cikkszám
antik Firenze	00007551080

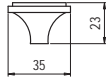
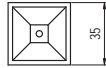

■ 546-000 - fém



szín	cikkszám
antik Firenze	00007551090

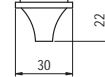
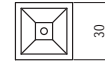

■ 540-75 - fém

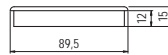
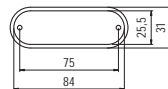

szín	cikkszám
antik Firenze	00007551020

■ 542-75 - fém

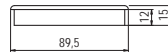
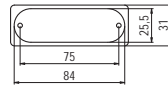

szín	cikkszám
antik Firenze	00007551030

■ 536-128 - fém

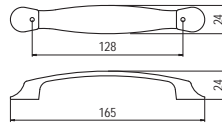

szín	cikkszám
antik Firenze	00007551040

■ 536-96 - fém

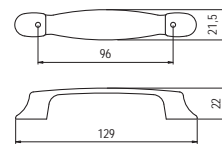

szín	cikkszám
antik Firenze	00007551050

■ 537-64 - fém

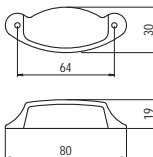

szín	cikkszám
antik Firenze	00007551060

■ 536-000 - fém

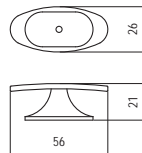

szín	cikkszám
antik Firenze	00007551070





## 695 - fém



furattáv (mm)	szín	cikkszám
gomb	antik Firenze	00007551890
96	antik Firenze	00007551900
128	antik Firenze	00007551910

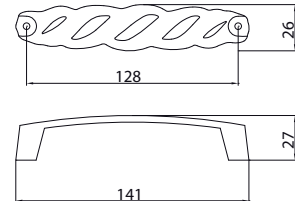
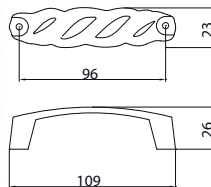

## 622.032 - fém

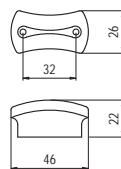

szín	cikkszám
antik Firenze	00007551590

## 622.128 - fém

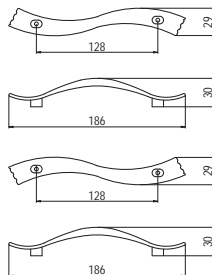

szín	cikkszám
antik Firenze - jobbos	00007551600
antik Firenze - balos	00007551610

## 622.096 - fém

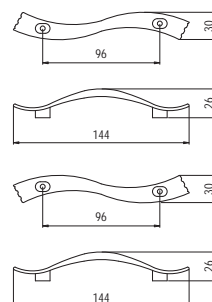

szín	cikkszám
antik Firenze - jobbos	00007551620
antik Firenze - balos	00007551630

## 4.110 • Bútorfogantyúk



688.000 - fém

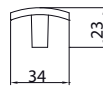
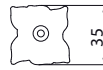
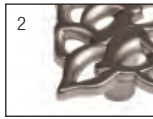

szín	cikkszám
1. króm	00007551940
2. nikkel	00007551941

688.096 - fém

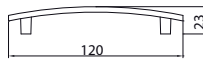
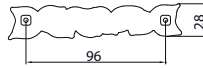

szín	cikkszám
1. króm	00007551950
2. nikkel	00007551951

688.128 - fém

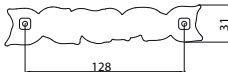

szín	cikkszám
1. króm	00007551960
2. nikkel	00007551961

688.224 - fém

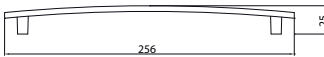
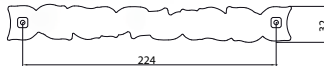
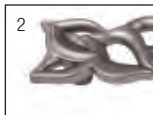

szín	cikkszám
1. króm	00007551970
2. nikkel	00007551971

648.128 - fém

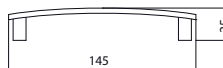
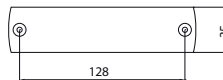

szín	cikkszám
1. nikkel	00007551770
2. bronz	00007551771

648.032 - fém

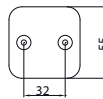
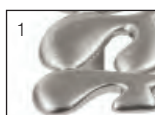

szín	cikkszám
1. nikkel	00007551780
2. bronz	00007551781



## 675 - fém

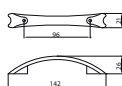

furattáv (mm)	szín	cikkszám
96	antik Firenze	00007551870
192	antik Firenze	00007551880

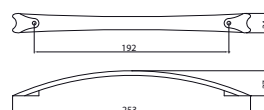

## 659 - fém

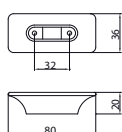

furattáv (mm)	szín	cikkszám
32	antik Firenze	00007551840
64	antik Firenze	00007551850
128	antik Firenze	00007551860

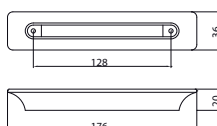
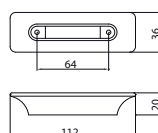

## 2028-25 - fém

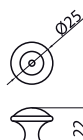

szín	cikkszám
antik Firenze	00007551700

## 2028-30 - fém

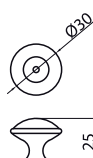

szín	cikkszám
antik Firenze	00007551701

## 2028-35 - fém

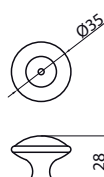

szín	cikkszám
antik Firenze	00007551702

## 4.112 • Bútorfogantyúk



■ 638-128 - fém

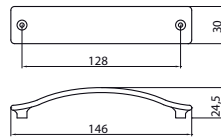

szín	cikkszám
antik Firenze	<b>00007551680</b>

■ 638-32 - fém

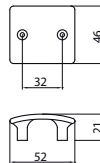

szín	cikkszám
antik Firenze	<b>00007551681</b>

■ 670-096 - fém

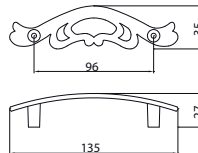

szín	cikkszám
1. antik Firenze	<b>00007551820</b>
2. króm	<b>00007551821</b>

■ 670-128 - fém

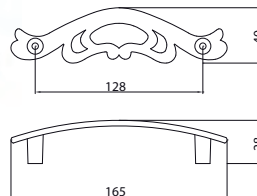

szín	cikkszám
1. antik Firenze	<b>00007551830</b>
2. króm	<b>00007551831</b>

■ 685-000 - fém

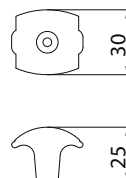

szín	cikkszám
1. króm	<b>00007551920</b>
2. antik Firenze	<b>00007551921</b>

■ 685-096 - fém

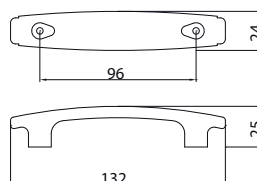

szín	cikkszám
1. króm	<b>00007551930</b>
2. antik Firenze	<b>00007551931</b>



## 628-224 - fém



szín	cikkszám
1. nikkel	00007551640
2. antik Firenze	00007551641

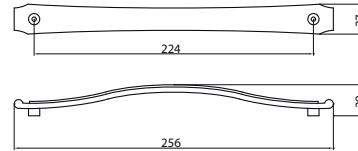
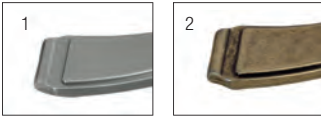

## 628-128 - fém



szín	cikkszám
antik Firenze	00007551642

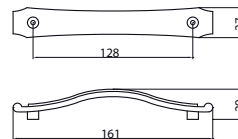

## 628-96 - fém



szín	cikkszám
1. antik Firenze	00007551643
2. nikkel	00007551644

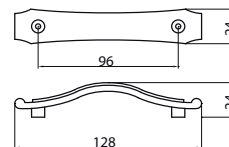

## 628-000 - fém



szín	cikkszám
antik Firenze	00007551645

## 4.114 • Bútorfogantyúk



■ 634-031 - fém

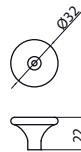

szín	cikkszám
1. antik Firenze	<b>00007551651</b>
2. króm	<b>00007551811</b>

■ 636-128 - fém

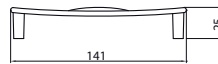
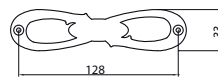

szín	cikkszám
antik Firenze	<b>00007551660</b>

■ 636-045 - fém



szín	cikkszám
antik Firenze	<b>00007551662</b>

■ 637-160- fém



szín	cikkszám
antik Firenze	<b>00007551670</b>

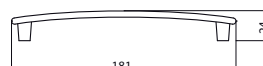
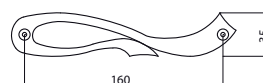





## E040-096 - fém

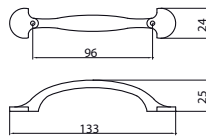

szín	cikkszám
antikolt	<b>00007651004</b>

## E041-096 - fém

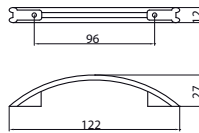

szín	cikkszám
antikolt	<b>00007651014</b>

## EM-603 - fém

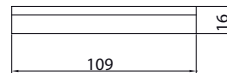
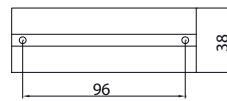
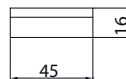
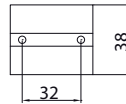

furattáv (mm)	szín	cikkszám
32	csillámos króm	<b>00007700060</b>
96	csillámos króm	<b>00007700070</b>

## BR-170 - fém

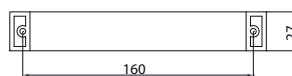
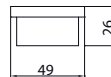
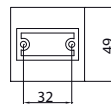

furattáv (mm)	szín	cikkszám
32	antik	<b>00007700100</b>
160	antik	<b>00007700110</b>

## 4.116 • Bútorfogantyúk



■ E042-096 - fém

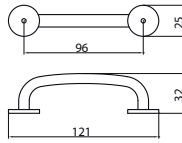

szín	cikkszám
antikolt	<b>00007651024</b>

■ E044-000 - fém

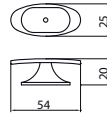

szín	cikkszám
fényes antikolt bronz	<b>00007651044</b>

■ E044-096 - fém

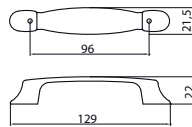

szín	cikkszám
fényes antikolt bronz	<b>00007651054</b>

■ E044-128 - fém

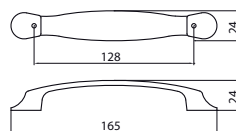

szín	cikkszám
fényes antikolt bronz	<b>00007651064</b>

■ E045-096 - fém

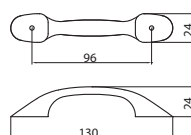

szín	cikkszám
fényes antikolt bronz	<b>00007651074</b>



## E046-096 - fém

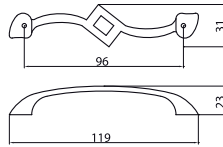

szín	cikkszám
fényes antikolt bronz	<b>00007651084</b>

## E046-128 - fém

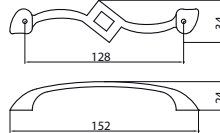
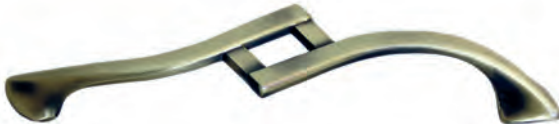

szín	cikkszám
fényes antikolt bronz	<b>00007651094</b>

## E047-096 - fém

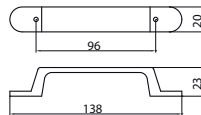

szín	cikkszám
fényes antikolt bronz	<b>00007651104</b>

## E048-096 - fém

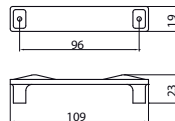

szín	cikkszám
fényes antikolt bronz	<b>00007651114</b>

## E048-128 - fém

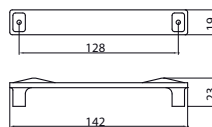

szín	cikkszám
fényes antikolt bronz	<b>00007651124</b>

## E049-096 - fém

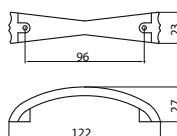

szín	cikkszám
fényes antikolt bronz	<b>00007651134</b>

## 4.118 • Bútorfogantyúk



■ M10 - fém / porcelán



szín	cikkszám
1. country bronz - kék motívum	00007550308
2. country bronz - barna virág	00007550309
3. antikolt bronz - zöld virág	00007550310
4. antikolt bronz - kék virág	00007550311
5. antikolt bronz - szürke virág	00007550312
6. antikolt bronz - színes virág	00007550313
7. antikolt bronz - barna virág	00007550314
8. antikolt bronz - búzakaralász	00007550315
9. antik Firenze - kőminta	00007550316
10. antik Firenze - barna motívum	00007550317
11. antik Firenze - aranyfüst	00007550318
12. antik Firenze - bordó / aranykoszorú	00007550319



■ M51 - fém / porcelán

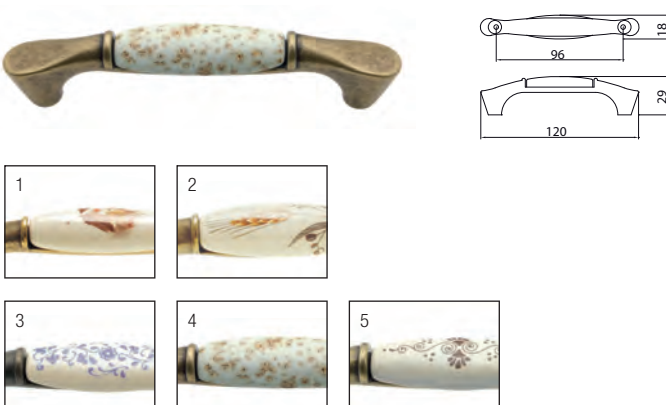

szín	cikkszám
1. antikolt bronz - barna virág	00007550350
2. antikolt bronz - búzakaralász	00007550351
3. country bronz - kék motívum	00007550352
4. antik Firenze - kőminta	00007550354
5. antik Firenze - barna motívum	00007550355



■ M17 - fém / porcelán

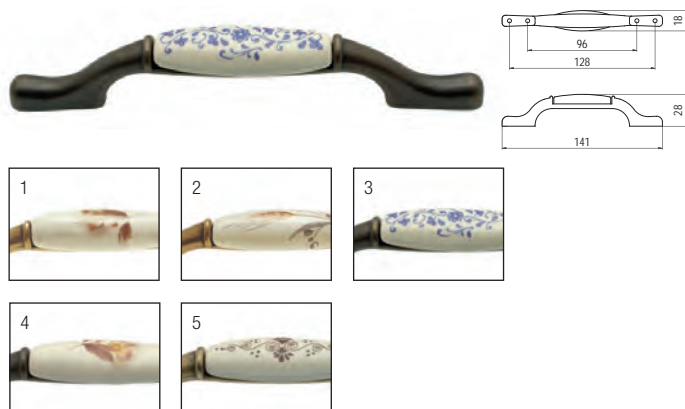

szín	cikkszám
1. antikolt bronz - barna virág	00007550330
2. antikolt bronz - búzakaralász	00007550331
3. country bronz - kék motívum	00007550332
4. country bronz - barna virág	00007550333
5. antik Firenze - barna motívum	00007550335

■ M50 - fém / porcelán

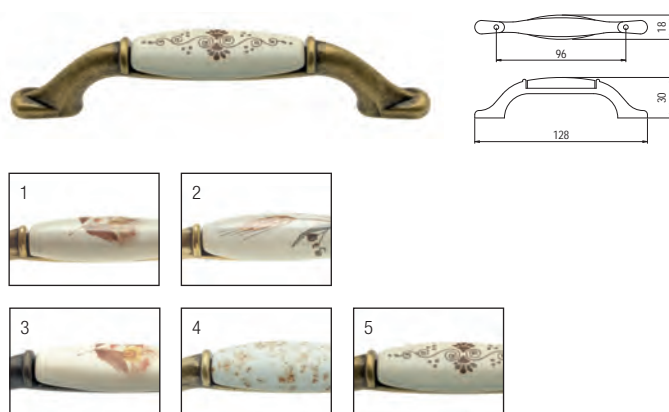

szín	cikkszám
1. antikolt bronz - barna virág	00007550340
2. antikolt bronz - búzakaralász	00007550341
3. country bronz - barna virág	00007550343
4. antik Firenze - kőminta	00007550344
5. antik Firenze - barna motívum	00007550345



## 4.120 • Bútorfogantyúk



### 110-32 - fém / porcelán

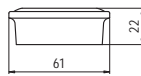
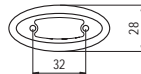

szín	cikkszám
1. antikolt bronz - minta nélkül	00007550020
2. antikolt bronz - barna virág	00007550021

### P07 - fém / porcelán

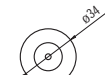

szín	cikkszám
1. country bronz - kék motívum	00007550278
2. country bronz - barna virág	00007550279
3. antikolt bronz - barna virág	00007550280
4. antikolt bronz - zöld virág	00007550281
5. antikolt bronz - kék virág	00007550282
6. antikolt bronz - szürke virág	00007550283
7. antikolt bronz - színes virág	00007550284
8. antikolt bronz - búzakaralás	00007550285
9. antik Firenze - kőminta	00007550286
10. antik Firenze - barna motívum	00007550287
11. antik Firenze - aranyfüst	00007550288
12. antik Firenze - bordó / aranykoszorú	00007550289







## P08 - fém / porcelán

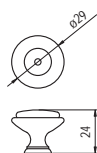

szín	cikkszám
1. antikolt bronz - barna virág	00007550290
2. antikolt bronz - zöld virág	00007550291
3. antikolt bronz - kék virág	00007550292
4. antikolt bronz - szürke virág	00007550293
5. antikolt bronz - színes virág	00007550294
6. antikolt bronz - búzakaralász	00007550295

## P01 - fém / porcelán

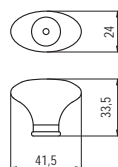

szín	cikkszám
1. antikolt bronz - barna virág	00007550260
2. antikolt bronz - színes virág	00007550264
3. antikolt bronz - búzakaralász	00007550265

## P03 - fém / porcelán

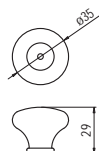

szín	cikkszám
1. antikolt bronz - barna virág	00007550270
2. antikolt bronz - zöld virág	00007550271
3. antikolt bronz - kék virág	00007550272
4. antikolt bronz - színes virág	00007550274
5. antikolt bronz - búzakaralász	00007550275

## P04 - fém / porcelán

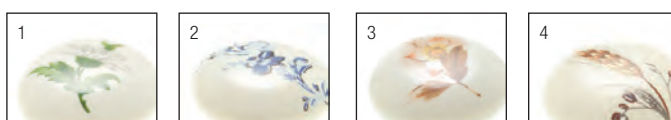
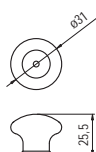

szín	cikkszám
1. antikolt bronz - zöld virág	00007550360
2. antikolt bronz - kék virág	00007550361
3. antikolt bronz - barna virág	00007550364
4. antikolt bronz - búzakaralász	00007550365

## 4.122 • Bútorfogantyúk



### ■ P23 - fém / porcelán



szín	cikkszám
1. antikolt bronz - kőminta	<b>00007550435</b>
2. antikolt bronz - minta nélkül	<b>00007550436</b>

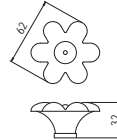

### ■ P18 - fém / porcelán

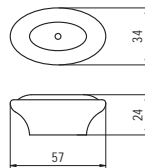

szín	cikkszám
country bronz - barna virág	<b>00007550440</b>

### ■ M01 - fém / porcelán

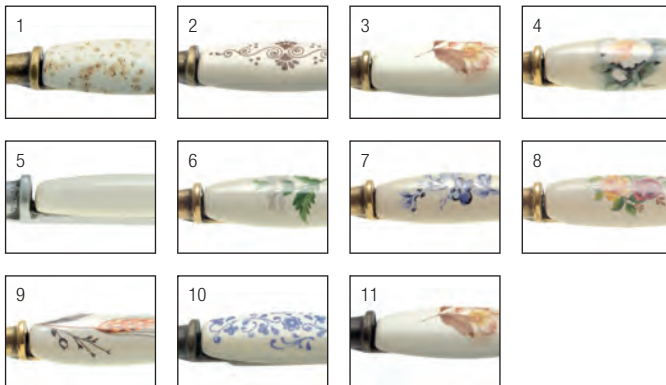
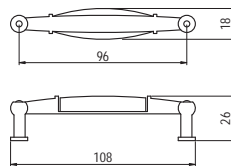

szín	cikkszám
1. antik Firenze - kőminta	<b>00007550246</b>
2. antik Firenze - barna motívum	<b>00007550247</b>
3. antikolt bronz - barna virág	<b>00007550250</b>
4. antikolt bronz - szürke virág	<b>00007550251</b>
5. ezüst - minta nélkül	<b>00007550252</b>
6. antikolt bronz - zöld virág	<b>00007550253</b>
7. antikolt bronz - kék virág	<b>00007550254</b>
8. antikolt bronz - színes virág	<b>00007550256</b>
9. antikolt bronz - búzakaiász	<b>00007550257</b>
10. country bronz - kék motívum	<b>00007550258</b>
11. country bronz - barna virág	<b>00007550259</b>



### ■ M12 - fém / porcelán



szín	cikkszám
antik Firenze - búzakaiász	<b>00007550472</b>

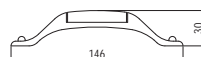
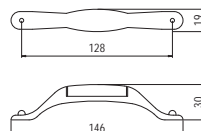



## M19 - fém / porcelán



szín	cikkszám
1. antik Firenze - búzskalász	<b>00007550480</b>
2. antik Firenze - barna motívum	<b>00007550481</b>
3. antik Firenze - barna virág	<b>00007550482</b>

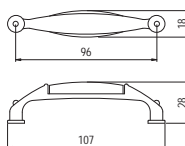

## M22 - fém / porcelán



szín	cikkszám
antik Firenze - barna motívum	<b>00007550490</b>

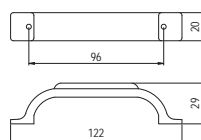

## 120-128 - fém / porcelán

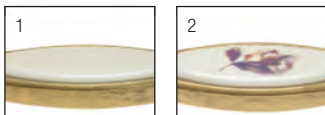

szín	cikkszám
1. antikolt bronz - minta nélkül	<b>00007550030</b>
2. antikolt bronz - barna virág	<b>00007550031</b>

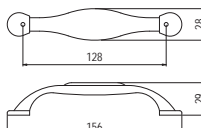

## M55 - fém / porcelán

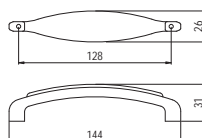

szín	cikkszám
antik Firenze - beige	<b>00007551540</b>

## 4.124 • Bútorfogantyúk



### E038-96 - fém / porcelán

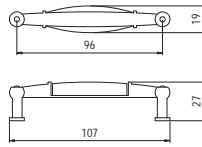

szín	cikkszám
1. antikolt bronz - barna virág	00007652000
2. antikolt bronz - szürke virág	00007652001
3. antikolt bronz - búzagalász	00007652002

### E039-26 - porcelán

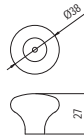

szín	cikkszám
1. barna virág	00007652020
2. szürke virág	00007652021
3. búzagalász	00007652022

### E050-96 - fém / porcelán

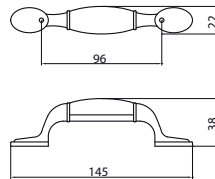

szín	cikkszám
1. antikolt bronz - barna virág	00007652030
2. antikolt bronz - szürke virág	00007652031
3. antikolt bronz - búzagalász	00007652032

### E051-96 - fém / porcelán

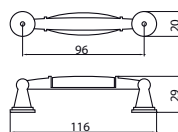

szín	cikkszám
1. antikolt bronz - barna virág	00007652040
2. antikolt bronz - szürke virág	00007652041
3. antikolt bronz - búzagalász	00007652042

### E052-96 - fém / porcelán

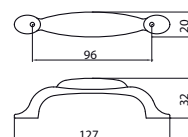

szín	cikkszám
1. antikolt bronz - barna virág	00007652050
2. antikolt bronz - szürke virág	00007652051
3. antikolt bronz - búzagalász	00007652052

## E053-33 - fém / porcelán



szín	cikkszám
1. antikolt bronz - barna virág	<b>00007652060</b>
2. antikolt bronz - szürke virág	<b>00007652061</b>
3. antikolt bronz - búzalkalász	<b>00007652062</b>

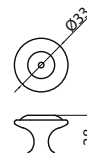

## C2027 - fém / porcelán, fém

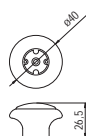

szín	cikkszám
matt bronz - arany virág	<b>00007500230</b>

## C2028 - fém / porcelán, fém

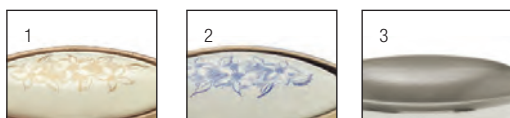

szín	cikkszám
1. matt bronz - arany virág	<b>00007500240</b>
2. antikolt bronz - kék virág	<b>00007500241</b>
3. galvanizált nikkelt	<b>00007500245</b>

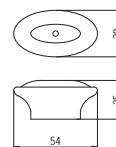

## C1017 - fém / porcelán



szín	cikkszám
1. matt bronz - arany virág	<b>00007500220</b>
2. antikolt bronz - kék virág	<b>00007500221</b>
3. antikolt ezüst- kék virág	<b>00007500222</b>

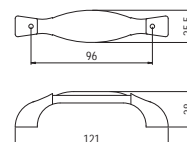

## 4.126 • Bútorfogantyúk

■ 1896-30 - fém / műanyag

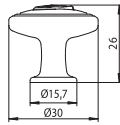

szín	cikkszám
1. króm - fehér	<b>00007304935</b>
2. antikolt réz - beige	<b>00007304936</b>



■ 1897-32 - fém / műanyag

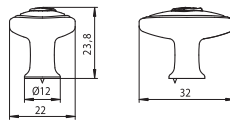

szín	cikkszám
1. króm - fehér	<b>00007304940</b>
2. antikolt réz - beige	<b>00007304941</b>

■ 1898-106 - fém / műanyag

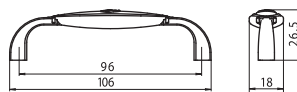

szín	cikkszám
1. króm - fehér	<b>00007304950</b>
2. antikolt réz - beige	<b>00007304951</b>

■ 1898-138 - fém / műanyag

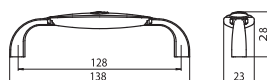

szín	cikkszám
antikolt réz - beige	<b>00007304956</b>



## 1973-106 - fém / műanyag

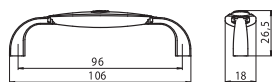

szín	cikkszám
antikolt réz - beige	<b>00007305050</b>

## 1973-138 - fém / műanyag

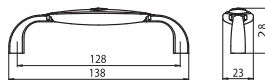

szín	cikkszám
antikolt réz - beige	<b>00007305055</b>

## 1889-67 - fém / műanyag

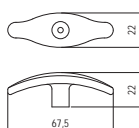

szín	cikkszám
antik bronz - minta nélkül	<b>00007306310</b>

## 1881-130 - fém / műanyag

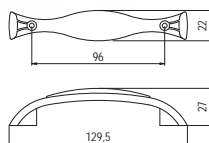

szín	cikkszám
antik bronz - minta nélkül	<b>00007306320</b>



## 1700-29 - fém / porcelán

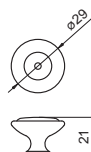

szín	cikkszám
1. antik bronz - tört porcelán	<b>00007306330</b>
2. antik bronz - minta nélkül	<b>00007306331</b>

## 1699-107 - fém / porcelán

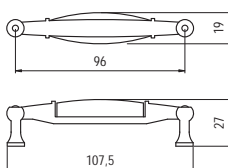
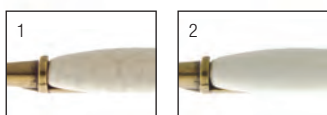

szín	cikkszám
1. antik bronz - tört porcelán	<b>00007306340</b>
2. antik bronz - minta nélkül	<b>00007306341</b>

## 4.128 • Bútorfogantyúk

### ■ SP1-33 - porcelán

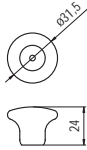

szín	cikkszám
fehér - arany	<b>00007421700</b>



### ■ SP1-38 - porcelán

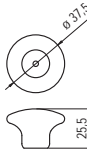

szín	cikkszám
fehér - arany	<b>00007421800</b>



### ■ SP12-35 - porcelán

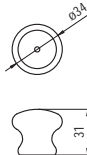

szín	cikkszám
fehér	<b>00007421600</b>



### ■ P10 - fém / porcelán

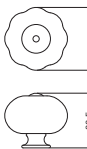

szín	cikkszám
1. törtfehér - réz	<b>00007550372</b>
2. fehér - réz	<b>00007550373</b>

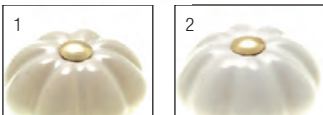

### ■ T 402-38 - porcelán

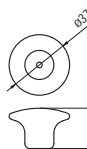

szín	cikkszám
fehér - arany	<b>00007608800</b>

### ■ T 404-35 - porcelán

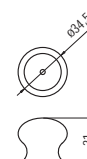

szín	cikkszám
fehér	<b>00007609000</b>

## SP54-27 - porcelán

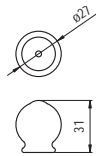

szín	cikkszám
1. színes - csíkokkal	<b>00007422230</b>
2. színes - pöttyökkel	<b>00007422231</b>

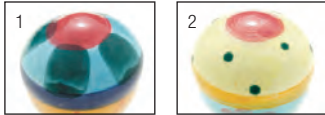

## SP58-38 - porcelán

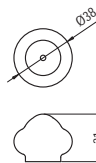

szín	cikkszám
színes	<b>00007422260</b>

## SP51-39 - porcelán

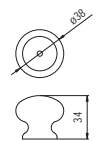

szín	cikkszám
mintás narancs	<b>00007422223</b>

## SP55-35 - porcelán

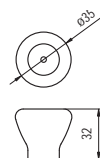

szín	cikkszám
narancs - zöld	<b>00007422240</b>

## SP59-29 - fém / porcelán

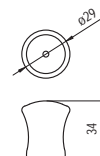

szín	cikkszám
rózsaszín - zöld	<b>00007422270</b>

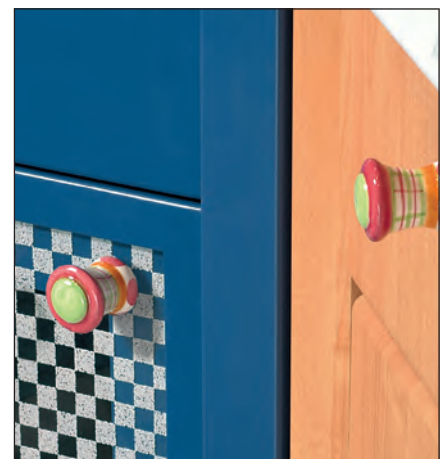

# 4.130 • Bútorfogantyúk



■ 1882-56 - fém



szín	cikkszám
antik ezüst	<b>00007250440</b>

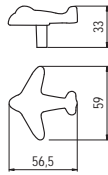

■ 1884-48 - fém



szín	cikkszám
antik ezüst	<b>00007250460</b>

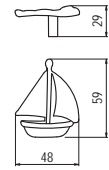

■ 1885-56 - fém



szín	cikkszám
antik ezüst	<b>00007250470</b>

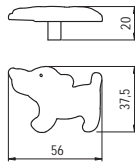

■ 1886-36 - fém



szín	cikkszám
antik ezüst	<b>00007250480</b>

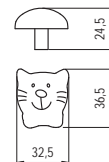

■ 1883-109 - fém

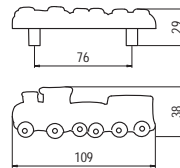

szín	cikkszám
antik ezüst	<b>00007250450</b>

■ 1887-41 - fém



szín	cikkszám
antik ezüst	<b>00007250491</b>

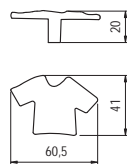

■ 1888-40 - fém



szín	cikkszám
antik ezüst	<b>00007250501</b>

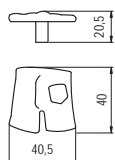

■ H069-45 - gumi



szín	cikkszám
színes	00007250200

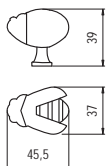

■ H147-47 - gumi



szín	cikkszám
piros	00007250320

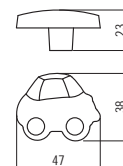

■ H148-40 - gumi



szín	cikkszám
fekete - fehér	00007250330

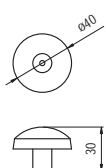

■ H156-40 - gumi



szín	cikkszám
színes	00007250400

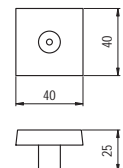

■ H150-53 - gumi



szín	cikkszám
narancs	00007250350

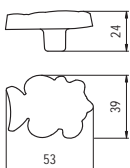

■ H157-50 - gumi



szín	cikkszám
színes	00007250410

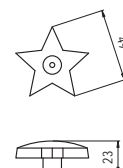

■ H158-51 - gumi



szín	cikkszám
szürke	00007250420

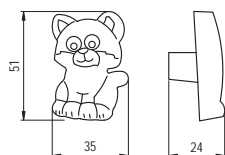

■ H159-50 - gumi



szín	cikkszám
zöld	00007250430



■ H152-44 - gumi



szín	cikkszám
színes	00007250360





# 4.132 • Bútorfogantyúk



**H 039-44** - műanyag



szín	cikkszám
piros	<b>00007250050</b>

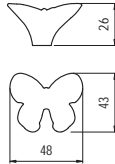

**H 040-40** - műanyag



szín	cikkszám
kék	<b>00007250060</b>

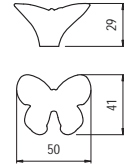

**H 041-42** - műanyag



szín	cikkszám
narancs	<b>00007250070</b>

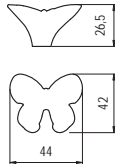

**H 049-41** - műanyag



szín	cikkszám
sárga	<b>00007250090</b>

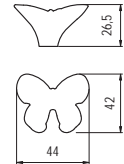

**H149-44** - gumi



szín	cikkszám
sárga	<b>00007250340</b>

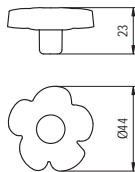

**H149-44** - gumi



szín	cikkszám
rózsaszín	<b>00007250342</b>

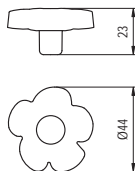

**H149-44** - gumi



szín	cikkszám
kék	<b>00007250341</b>

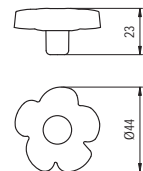



## H 022-56 - műanyag



szín	cikkszám
barna	<b>00007250010</b>

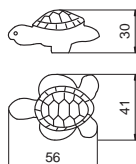

## H 024-65 - műanyag



szín	cikkszám
barna	<b>00007250016</b>



## H 025-57 - műanyag



szín	cikkszám
sárga	<b>00007250019</b>

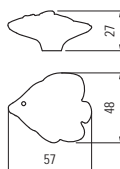

## H 026-61 - műanyag



szín	cikkszám
fekete	<b>00007250022</b>



## H 027-57 - műanyag



szín	cikkszám
sárga	<b>00007250025</b>

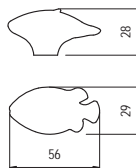

## H 029-52 - műanyag



szín	cikkszám
beige	<b>00007250031</b>

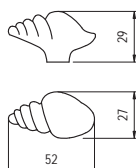

## 4.134 • Bútorfogantyúk



■ H 023-55 - műanyag



szín	cikkszám
barna	<b>00007250013</b>

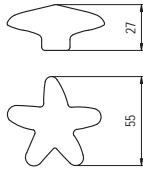

■ H 061-49 - műanyag



szín	cikkszám
világoskék	<b>00007250151</b>

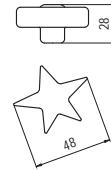

■ H 125-50 - műanyag

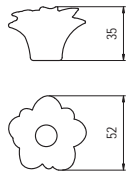

szín	cikkszám
sárga	<b>00007250290</b>

■ H 127-38 - műanyag

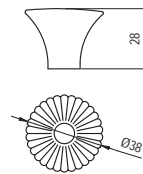

szín	cikkszám
fehér	<b>00007250310</b>
rózsaszín	<b>00007250311</b>

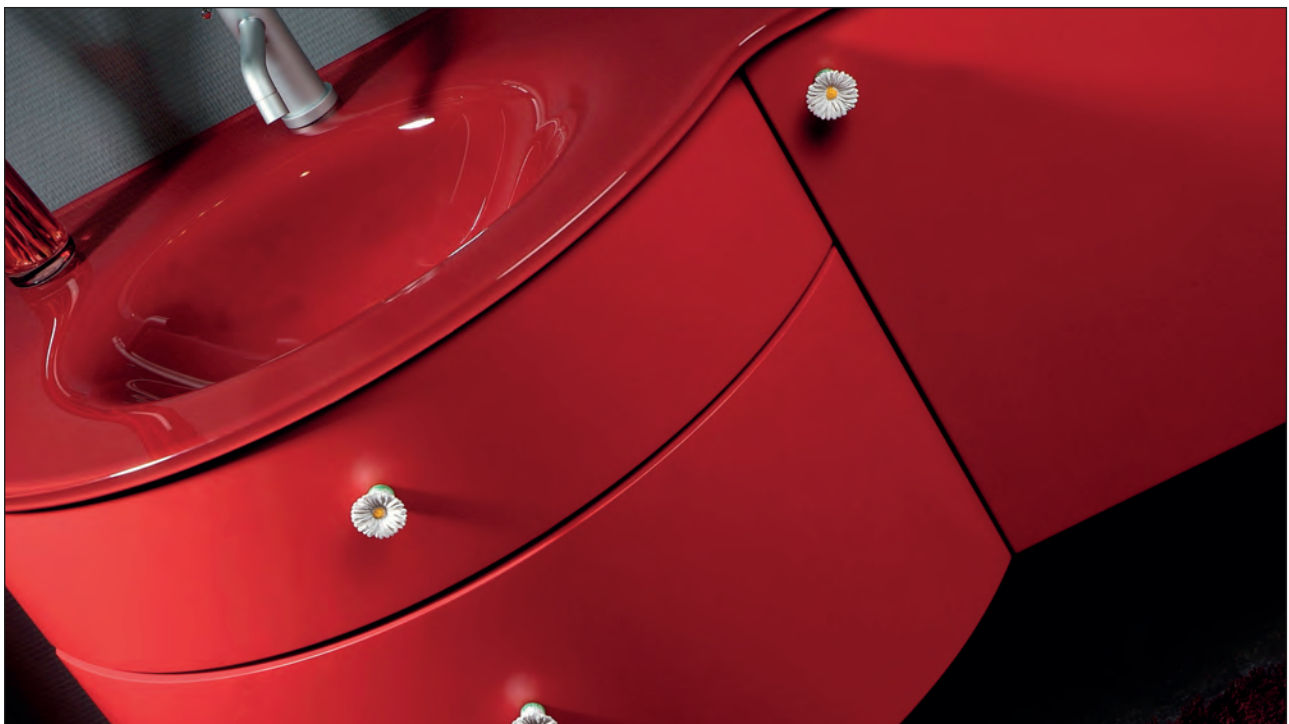

## 01022-153 - műanyag

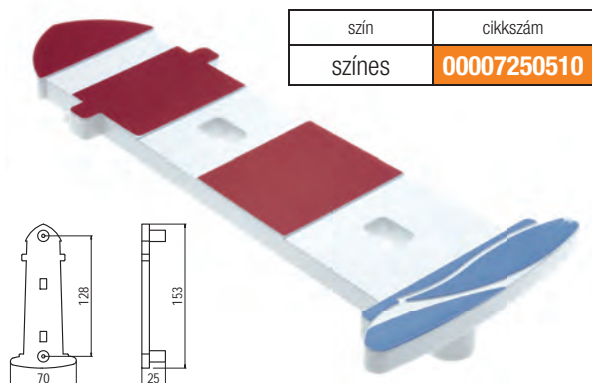

## 01023-34 - műanyag

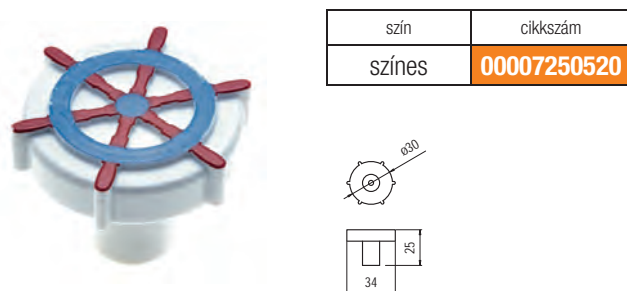

## 8004-164 - műanyag



minta	cikkszám
1. vonat	<b>00007432500</b>
2. tündér	<b>00007432501</b>
3. autó	<b>00007432502</b>

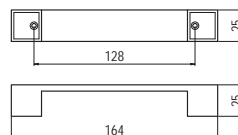

## 8045-36 - műanyag



minta	cikkszám
1. vonat	<b>00007432520</b>
2. tündér	<b>00007432521</b>
3. autó	<b>00007432522</b>
4. kacsa	<b>00007432523</b>
5. kutya	<b>00007432524</b>
6. bárány	<b>00007432525</b>
7. cica	<b>00007432526</b>
8. egér	<b>00007432531</b>

## 427 P - műanyag

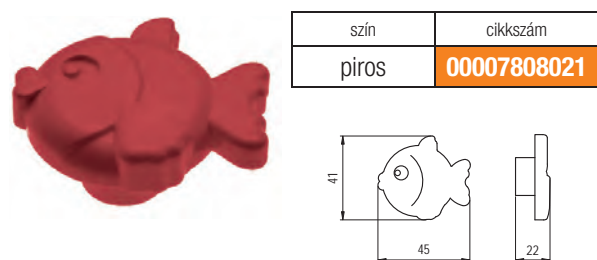

## 427 G - műanyag

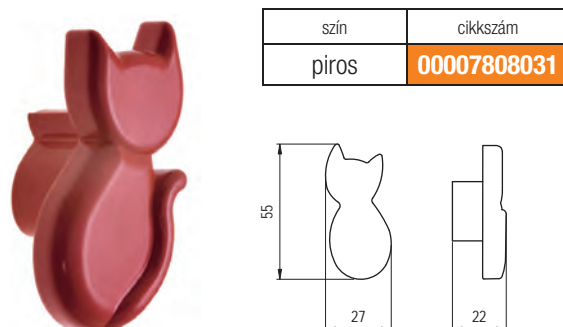



# 4.136 • Bútorfogantyúk



■ T-513 - gumi



szín	cikkszám
fekete-fehér	<b>00007611130</b>

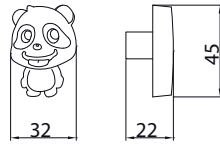

■ T-509 - gumi



szín	cikkszám
szürke	<b>00007611080</b>

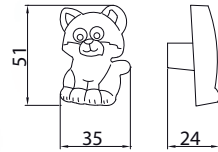

■ T-514 - gumi



szín	cikkszám
szürke	<b>00007611140</b>

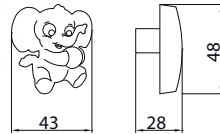

■ T-504 - gumi



szín	cikkszám
színes	<b>00007611030</b>

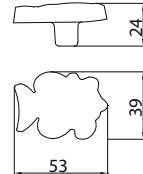

■ T-510 - gumi



szín	cikkszám
színes	<b>00007611090</b>

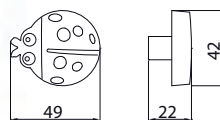

■ T-508 - gumi



szín	cikkszám
zöld	<b>00007611070</b>

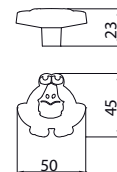

■ T-505 - gumi



szín	cikkszám
színes	<b>00007611040</b>

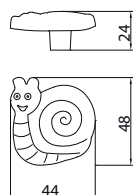

■ T-507 - gumi



szín	cikkszám
piros-fehér	<b>00007611060</b>

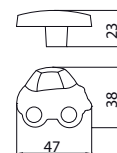



**T-511** - gumi

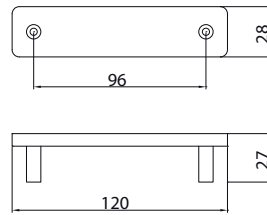

szín	cikkszám
kék	<b>00007611110</b>
sárga	<b>00007611100</b>

**T-506** - gumi

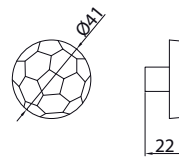

szín	cikkszám
fekete-fehér	<b>00007611050</b>

**T-500** - gumi



szín	cikkszám
pink	<b>00007611000</b>
sárga	<b>00007611002</b>
kék	<b>00007611001</b>

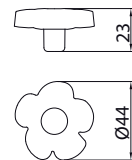

**T-501** - gumi



szín	cikkszám
színes	<b>00007611010</b>

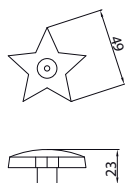

**T-502** - gumi



szín	cikkszám
színes	<b>00007611020</b>

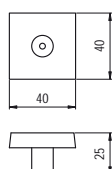

## 4.138 • Bútorfogantyúk

### 426 X - műanyag

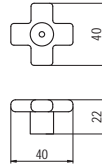
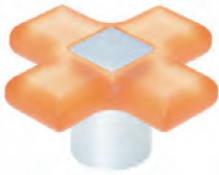

szín	cikkszám
1. kék áttetsző	00007808000
2. narancs áttetsző	00007808002
3. piros áttetsző	00007808003

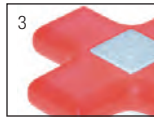
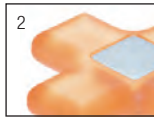
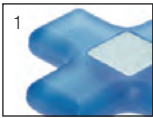

### 399 - műanyag

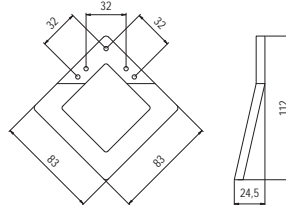

szín	cikkszám
1. narancs áttetsző	00007808040
2. narancs	00007808050



### 8151-60 - műanyag

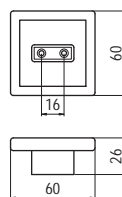

szín	cikkszám
1. króm áttetsző	00007432880
2. króm fekete	00007432881



### 96/M - műanyag

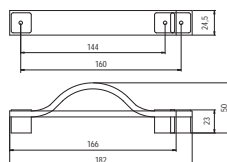

szín	cikkszám
piros áttetsző	00007808110



## 8116-50 - műanyag

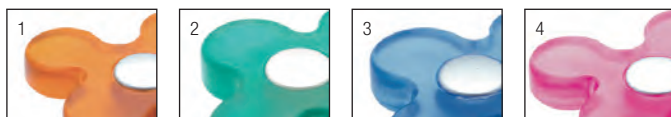
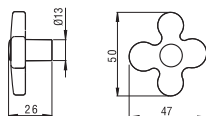

szín	cikkszám
1. narancs áttetsző - alumínium	00007432320
2. zöld áttetsző - alumínium	00007432321
3. kék áttetsző - alumínium	00007432322
4. rózsaszín áttetsző - alumínium	00007432323



## 8117-34 - műanyag

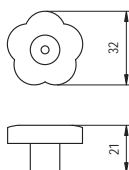

szín	cikkszám
1. világoszöld áttetsző	00007432330
2. világos rózsaszín áttetsző	00007432331
3. piros áttetsző	00007432332
4. világoskék áttetsző	00007432333

## 8118-30 - műanyag

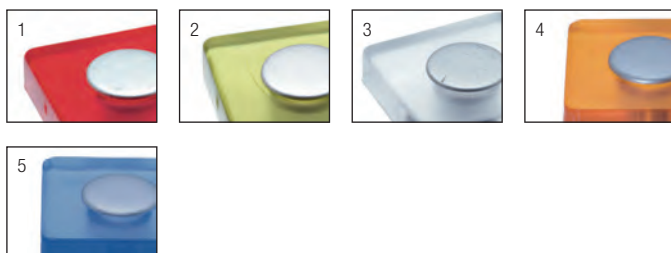
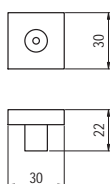

szín	cikkszám
1. piros áttetsző - alumínium	00007432340
2. olívazöld áttetsző - alumínium	00007432341
3. áttetsző - alumínium	00007432342
4. narancs áttetsző - alumínium	00007432343
5. világoskék áttetsző - alumínium	00007432344

## 4.140 • Bútorfogantyúk

### 0089-144 - műanyag

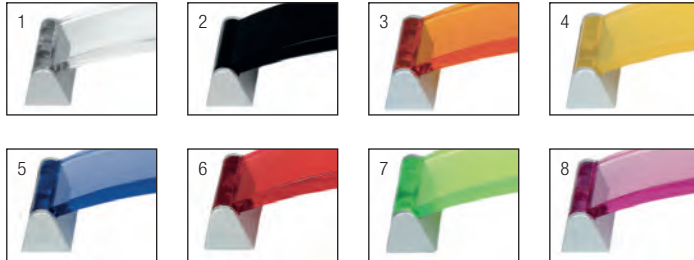
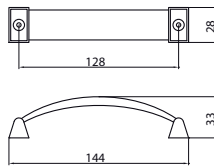

szín	cikkszám
1. áttetsző - alumínium	00007432890
2. fekete - alumínium	00007432891
3. narancs - alumínium	00007432892
4. sárga - alumínium	00007432893
5. kék - alumínium	00007432894
6. piros - alumínium	00007432895
7. zöld - alumínium	00007432896
8. rózsaszín - alumínium	00007432897

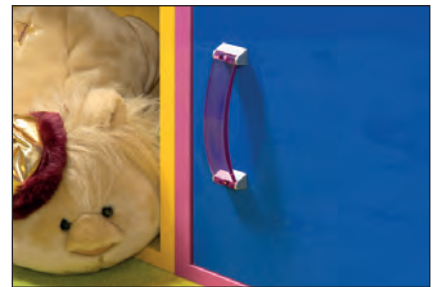

### 8178-137 - műanyag

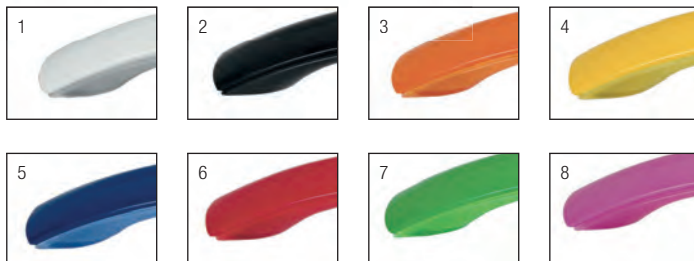
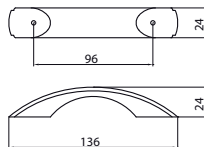

szín	cikkszám
1. fehér	00007432930
2. fekete	00007432931
3. narancs	00007432932
4. sárga	00007432933
5. kék	00007432934
6. piros	00007432935
7. zöld	00007432936
8. rózsaszín	00007432937

### 8200-82 - műanyag

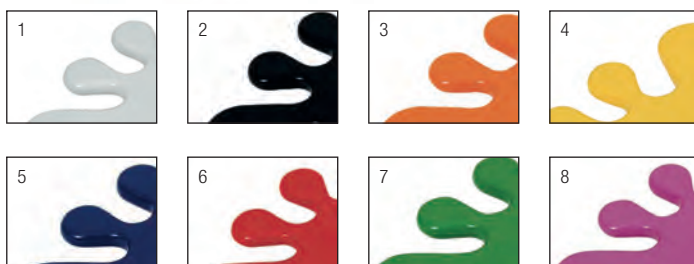
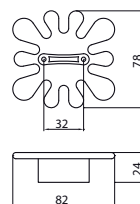

szín	cikkszám
1. fehér	00007432940
2. fekete	00007432941
3. narancs	00007432942
4. sárga	00007432943
5. sötétkék	00007432944
6. piros	00007432945
7. zöld	00007432946
8. rózsaszín	00007432947

## 8119-126 - műanyag

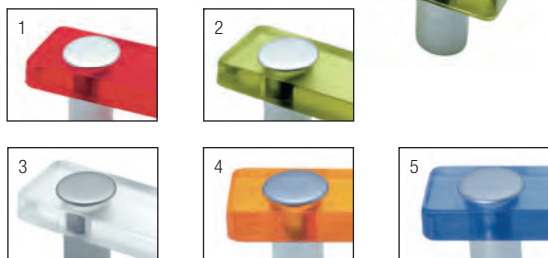
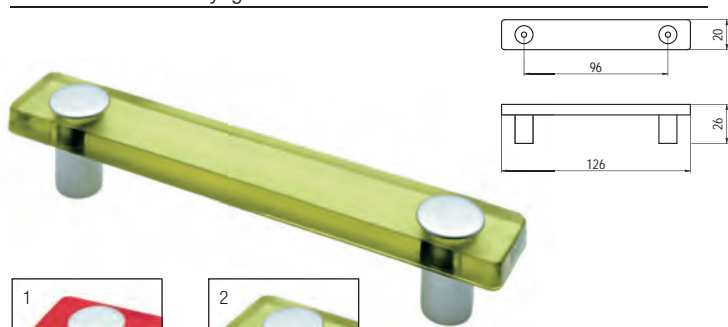

szín	cikkszám
1. piros áttetsző - alumínium	00007432350
2. olívazöld áttetsző - alumínium	00007432351
3. áttetsző - alumínium	00007432352
4. narancs áttetsző - alumínium	00007432353
5. világoskék áttetsző - alumínium	00007432354



## 8142 - műanyag



szín	cikkszám
1. matt króm - rózsaszín	00007432950
2. matt króm - ezüst	00007432951
3. matt króm - lila	00007432952

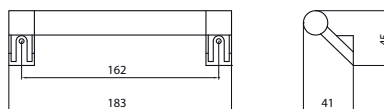

## 8151 - műanyag

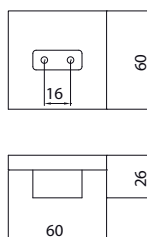
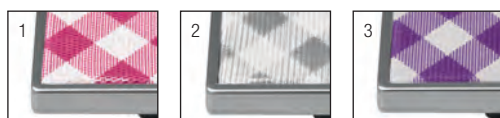

szín	cikkszám
1. matt króm - rózsaszín	00007432960
2. matt króm - ezüst	00007432961
3. matt króm - lila	00007432962

## 4.142 • Bútorfogantyúk



### 8163-47 - műanyag

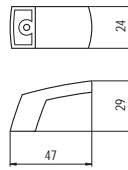
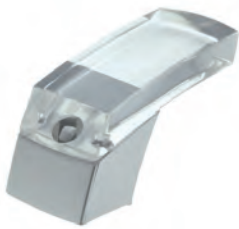

szín	cikkszám
1. áttetsző - matt króm	00007432800
2. wenge - króm	00007432801
3. matt króm - króm	00007432802



### 8111-80 - műanyag

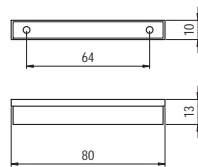

szín	cikkszám
1. króm - fekete	00007432860
2. króm - fehér	00007432861

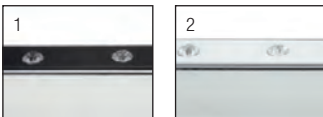

### 8095-148 - műanyag

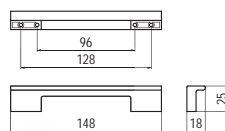

szín	cikkszám
króm - fekete	00007432870

### 8131-78 - műanyag

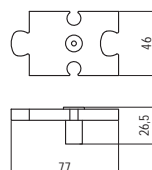

szín	cikkszám
átlászó - alumínium	00007432660

## 306 - műanyag

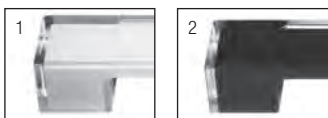

szín	cikkszám
1. áttetsző-fehér	00007808140
2. áttetsző-fekete	00007808141

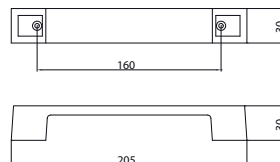

## 37B - műanyag

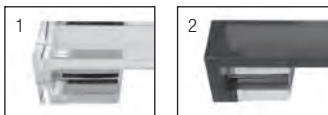

szín	cikkszám
1. áttetsző-króm	00007808130
2. áttetsző fekete-króm	00007808131

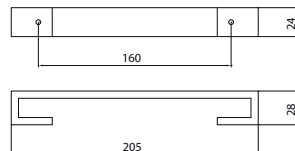

## MB0909700 - gumi



**CONFAIÖNIERI**

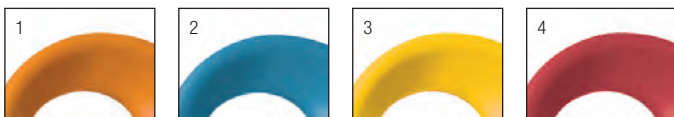

szín	cikkszám
1. narancs	00007590000
2. kék	00007590001
3. sárga	00007590002
4. piros	00007590010

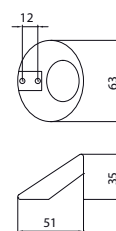

## MB0913000 - gumi



**CONFAIÖNIERI**

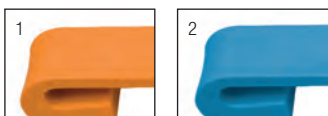

szín	cikkszám
1. narancs	00007590020
2. kék	00007590021

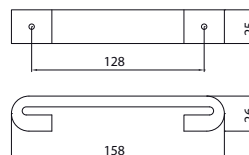



## 4.144 • Bútorfogantyúk

### 8014-184 - műanyag



szín	cikkszám
fekete bőrhatású	<b>00007432162</b>

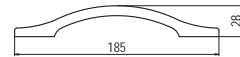
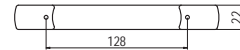

### 8059-176 - műanyag



szín	cikkszám
barna bőrhatású	<b>00007432141</b>

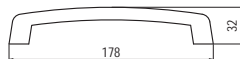
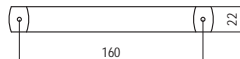

### 8077-56 - műanyag

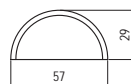
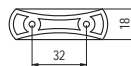

szín	cikkszám
króm - fekete bőrhatású	<b>00007432600</b>

### 8151-60 - műanyag

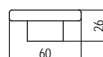
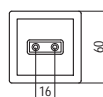

szín	cikkszám
1. króm - fekete bőrhatású	<b>00007432760</b>
2. króm - beige bőrhatású	<b>00007432761</b>
3. króm - barna bőrhatású	<b>00007432762</b>
4. króm - wenge	<b>00007432763</b>
5. króm - matt króm	<b>00007432764</b>



## 8109-180 - műanyag



szín	cikkszám
wenge - matt króm	<b>00007432610</b>

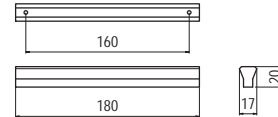

## 8104-40 - műanyag

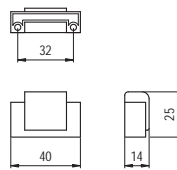

szín	cikkszám
wenge - alumínium	<b>00007432390</b>

## 8103-136 - műanyag



szín	cikkszám
wenge - alumínium	<b>00007432400</b>

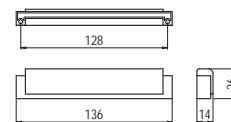

## 8132-40 - műanyag

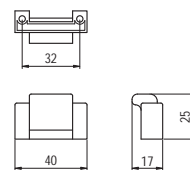

szín	cikkszám
fekete - matt króm	<b>00007432670</b>

## 8133-136 - műanyag



szín	cikkszám
fekete - matt króm	<b>00007432680</b>

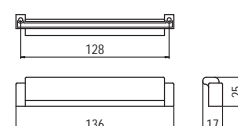

## 4.146 • Bútorfogantyúk



■ 8086-44 - műanyag

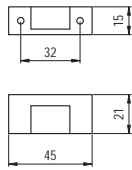

szín	cikkszám
wenge - alumínium	<b>00007432360</b>



■ 8086-172 - műanyag



szín	cikkszám
wenge - alumínium	<b>00007432370</b>

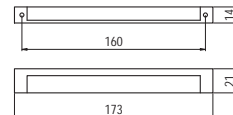

■ 8147-138 - műanyag



szín	cikkszám
wenge - matt króm	<b>00007432750</b>

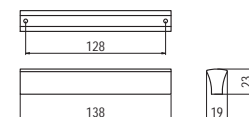

■ 8147-202 - műanyag



szín	cikkszám
wenge - matt króm	<b>00007432751</b>

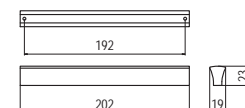

## 8105-144 - műanyag



szín	cikkszám
wenge - alumínium	<b>00007432380</b>

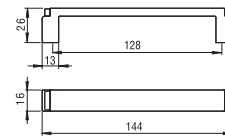

## 8135-202 - műanyag



szín	cikkszám
inox - matt nikkell	<b>00007432690</b>

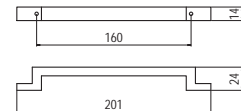

## 8137-137 - műanyag

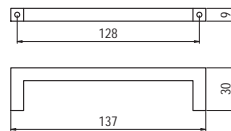

szín	cikkszám
1. matt nikkell	<b>00007432700</b>
2. matt króm	<b>00007432701</b>
3. fekete	<b>00007432702</b>
4. fehér	<b>00007432703</b>

## SM 095-42 - műanyag

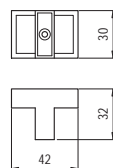

szín	cikkszám
matt króm	<b>00007422710</b>

## 0618-64 - műanyag

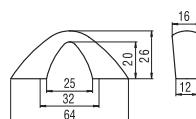

szín	cikkszám
1. fekete	<b>00007408500</b>
2. fehér	<b>00007408600</b>

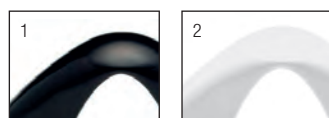

## 4.148 • Bútorfogantyúk



### 8006-25 - műanyag

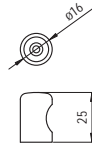

szín	cikkszám
1. matt nikkell	00007432110
2. matt króm	00007432111

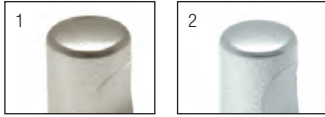

### 8076-15 - műanyag

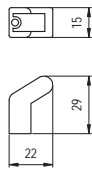

szín	cikkszám
1. matt nikkell	00007432130
2. matt króm	00007432131

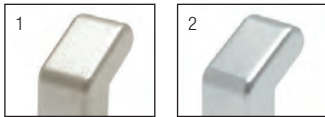

### 8066-36 - műanyag

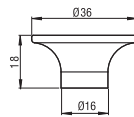

szín	cikkszám
1. matt nikkell	00007432170
2. matt króm	00007432171



### 8011-110 - műanyag

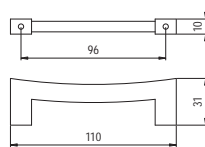

szín	cikkszám
1. matt króm	00007432210
2. matt nikkell	00007432211

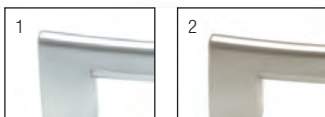

### 8004-164 - műanyag



szín	cikkszám
matt króm	00007432261

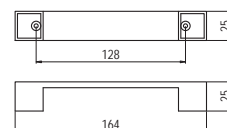



## 8015-25 - műanyag

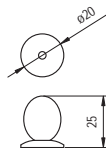

szín	cikkszám
1. matt nikkel	<b>00007432090</b>
2. matt króm	<b>00007432091</b>

## 8059-176 - műanyag



szín	cikkszám
matt króm	<b>00007432140</b>

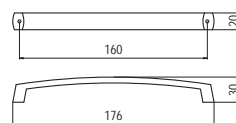

## 8059-240 - műanyag



szín	cikkszám
matt króm	<b>00007432150</b>

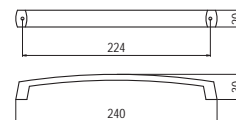

## 8014-184 - műanyag

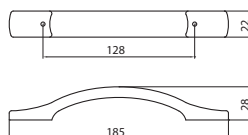

szín	cikkszám
1. matt króm	<b>00007432160</b>
2. matt nikkel	<b>00007432161</b>

## 8045-36 - műanyag

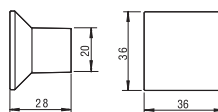

szín	cikkszám
1. matt nikkel	<b>00007432180</b>
2. matt króm	<b>00007432181</b>



■ 8013-148 - műanyag



szín	cikkszám
matt króm	00007432251

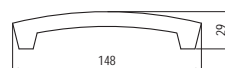
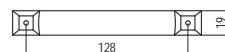

■ 396/A - műanyag

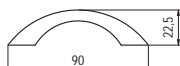
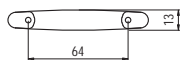

szín	cikkszám
matt alumínium	00007808120

## 8193 - műanyag

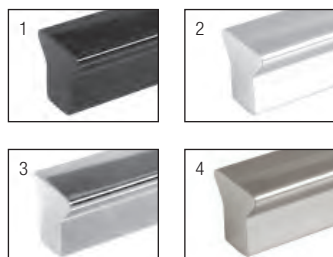

furattáv (mm)	szín			
	1. fekete	2. fehér	3. króm	4. nikkell
160	00007433000	00007433001	00007433002	00007433003
192	00007433010	00007433011	00007433012	00007433013
128 x 2	00007433020	00007433021	00007433022	00007433023
192 x 2	00007433030	00007433031	00007433032	00007433033
160 x 3	00007433040	00007433041	00007433042	00007433043

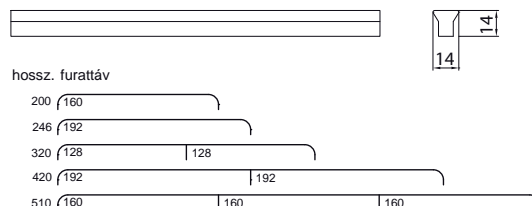

## 8214 - műanyag

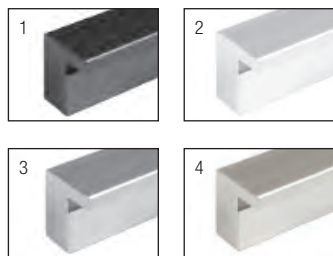

furattáv (mm)	szín			
	1. fekete	2. fehér	3. króm	4. nikkell
160	00007433100	00007433101	00007433102	00007433103
192	00007433110	00007433111	00007433112	00007433113
128 x 2	00007433120	00007433121	00007433122	00007433123
192 x 2	00007433130	00007433131	00007433132	00007433133
160 x 3	00007433140	00007433141	00007433142	00007433143

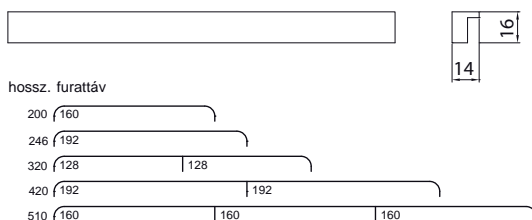

## 8217 - műanyag

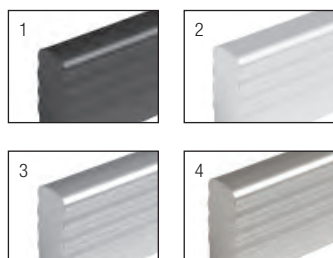

furattáv (mm)	szín			
	1. fekete	2. fehér	3. króm	4. nikkell
160	00007433200	00007433201	00007433202	00007433203
192	00007433210	00007433211	00007433212	00007433213
128 x 2	00007433220	00007433221	00007433222	00007433223
192 x 2	00007433230	00007433231	00007433232	00007433233
160 x 3	00007433240	00007433241	00007433242	00007433243

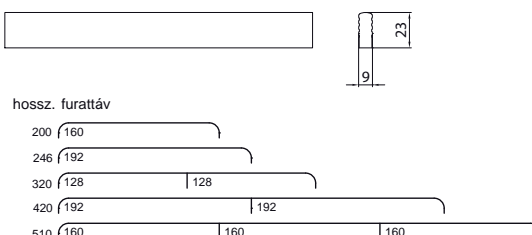

## 4.152 • Bútorfogantyúk

### SM 570-128 - műanyag

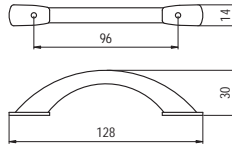

szín	cikkszám
kék gumihatású - króm	00007429200



### P 91/B-32 - műanyag

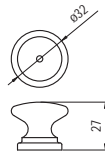

szín	cikkszám
rózsagyökér	00007801500

### P 214/C-128 - műanyag



szín	cikkszám
matt króm - cseresznye	00007805609

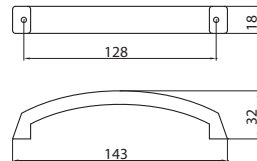

### 0549-134 - műanyag

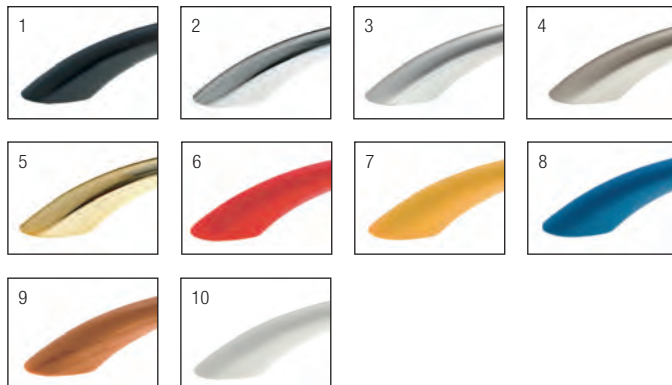
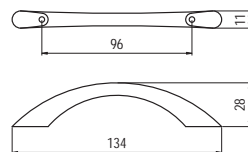

szín	cikkszám
1. fekete	00007404200
2. króm	00007404220
3. matt króm	00007404240
4. matt nikkel	00007404260
5. arany	00007404280
6. piros	00007404282
7. sárga	00007404284
8. kék	00007404286
9. cseresznye	00007404290
10. fehér	00007404300



## 0549-97 - műanyag

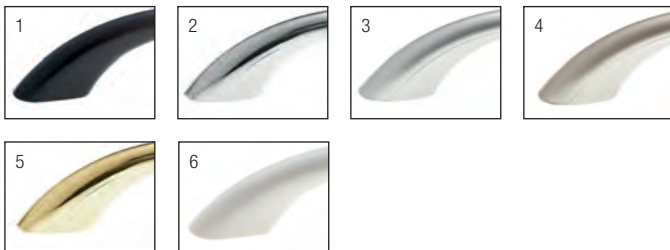
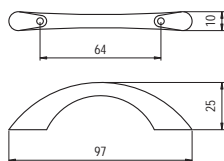

szín	cikkszám
1. fekete	00007404900
2. króm	00007404920
3. matt króm	00007404940
4. matt nikkél	00007404960
5. arany	00007404970
6. fehér	00007405000



## P 201/B-96 - műanyag

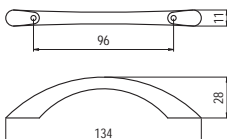

szín	cikkszám
rózsagyökér	00007804300

## 0548-38 - műanyag

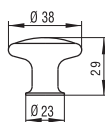

szín	cikkszám
fehér	00007404000



## P 91-27 - műanyag

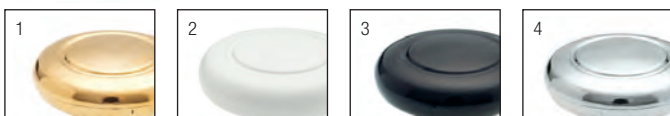
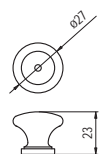

szín	cikkszám
1. arany	00007800100
2. fehér	00007800200
3. fekete	00007800300
4. króm	00007800500



## 4.154 • Bútorfogantyúk

### ■ P 91/B-32 - műanyag



szín	cikkszám
1. arany	00007801000
2. fehér	00007801100
3. fekete	00007801200
4. króm	00007801300
5. matt króm	00007801303
6. matt nikkel	00007801306

### ■ P 201/A-64 - műanyag

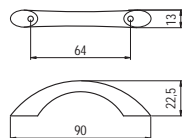

szín	cikkszám
króm	00007802400

### ■ P 201/C-128 - műanyag

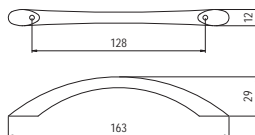

szín	cikkszám
1. fehér	00007804700
2. fekete	00007804800
3. króm	00007805000
4. matt króm	00007805003
5. matt nikkel	00007805006

### ■ 0287-106 - műanyag

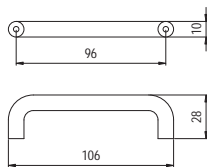

szín	cikkszám
fehér	00007401200



### ■ SM 447-40 - műanyag

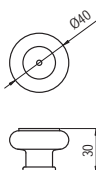

szín	cikkszám
fehér	00007421200



### ■ SM 447-32 - műanyag

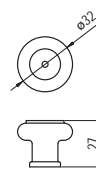

szín	cikkszám
fehér	00007420800



## SM 391-34 - műanyag

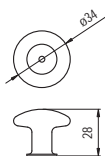

szín	cikkszám
1. arany - fehér	00007423400
2. króm - nikkell	00007423420
3. arany - barna	00007424300
4. króm - kék gumih.	00007424400



## SM 39-100 - műanyag

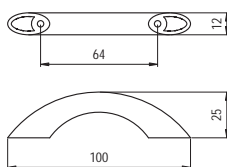

szín	cikkszám
arany - fehér	00007424900

## SM 592-86 - műanyag

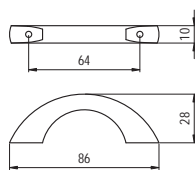

szín	cikkszám
fehér - arany	00007425800

## SM 592-124 - műanyag

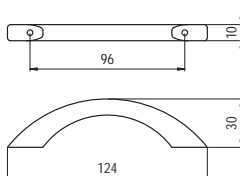

szín	cikkszám
1. arany - fehér	00007425900
2. fehér - arany	00007426000
3. m. nikkell - bükk	00007426710
4. kék gumih. - króm	00007427100
5. m. nikkell - cseresznye	00007427400



## 4.156 • Bútorfogantyúk

### 57 - műanyag



szín	cikkszám
matt alumínium	<b>00007808070</b>

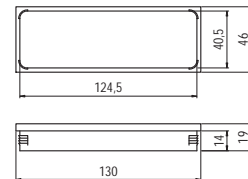

bemarási méret:  
125 x 41 x 15 mm

### P 273-35 - műanyag

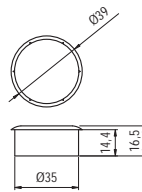

szín	cikkszám
1. fehér	<b>00007807202</b>
2. fekete	<b>00007807204</b>
3. arany	<b>00007807206</b>
4. króm	<b>00007807208</b>
5. matt króm	<b>00007807210</b>



### P 274-125 - műanyag

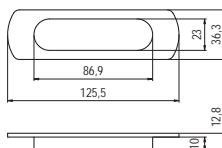
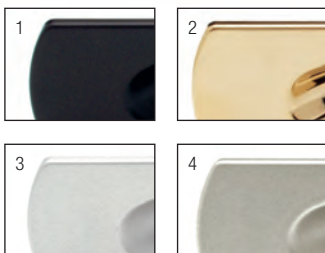

szín	cikkszám
1. fekete	<b>00007807216</b>
2. arany	<b>00007807218</b>
3. matt króm	<b>00007807222</b>
4. matt nikkél	<b>00007807224</b>



## F 564-96 - fa

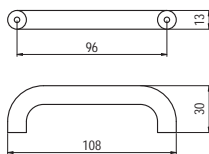

szín	cikkszám
bükk	<b>00007904400</b>

## S 70-30 - fa

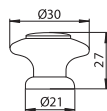

szín	cikkszám
1. lakkozott tölgy	<b>00008003900</b>
2. pácolt tölgy	<b>00008004000</b>
3. lakkozott fenyő	<b>00008004100</b>



## S 70-35 - fa

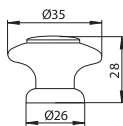

szín	cikkszám
1. nyers tölgy	<b>00008004200</b>
2. lakkozott tölgy	<b>00008004300</b>
3. pácolt tölgy	<b>00008004400</b>
4. nyers fenyő	<b>00008004405</b>
5. lakkozott fenyő	<b>00008004500</b>



## S 70-44 - fa

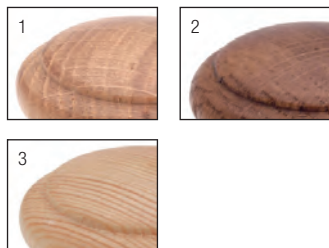
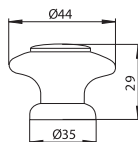

szín	cikkszám
1. lakkozott tölgy	<b>00008004700</b>
2. pácolt tölgy	<b>00008004800</b>
3. lakkozott fenyő	<b>00008004900</b>





## 4.158 • Bútorfogantyúk

### ■ G 17-110 - fa

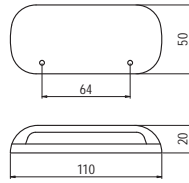

szín	cikkszám
nyers bükk	00008000305

### ■ S 138-120 - fa

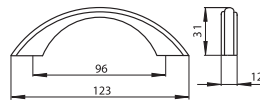

szín	cikkszám
1. pácolt tölgy	00008002200
2. lakkozott fenyő	00008002300
3. nyers fenyő	00008002310



### ■ S 138-88 - fa

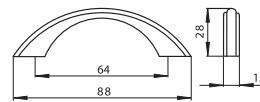

szín	cikkszám
lakkozott fenyő	00008002700

### ■ S 30-112 - fa

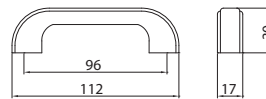

szín	cikkszám
1. nyers tölgy	00008002800
2. lakkozott tölgy	00008002900
3. lakkozott fenyő	00008003100



### ■ S 30-82 - fa

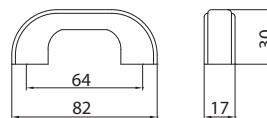

szín	cikkszám
lakkozott fenyő	00008003500

### ■ S 113-108 - fa

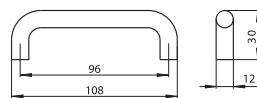

szín	cikkszám
lakkozott fenyő	00008000700



## S 113-76 - fa

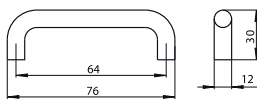

szín	cikkszám
lakkozott fenyő	<b>00008001100</b>

## S 87-30 - fa

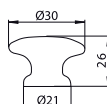

szín	cikkszám
1. lakkozott tölgy	<b>00008005100</b>
2. lakkozott fenyő	<b>00008005300</b>

## S 87-35 - fa

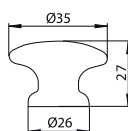

szín	cikkszám
1. nyers tölgy	<b>00008005400</b>
2. lakkozott tölgy	<b>00008005500</b>
3. pácolt tölgy	<b>00008005600</b>
4. lakkozott fenyő	<b>00008005700</b>

## S 87-44 - fa

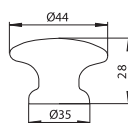

szín	cikkszám
1. lakkozott tölgy	<b>00008005900</b>
3. pácolt tölgy	<b>00008006000</b>
4. lakkozott fenyő	<b>00008006100</b>

## S 300-35 - fa

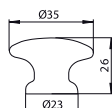

szín	cikkszám
nyers bükk	<b>00008003600</b>

## 4.160 • Bútorfogantyúk

### ■ S 514-154 - fa

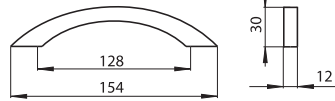

szín	cikkszám
1. lakozott bükk	<b>00008008991</b>
2. lakozott fenyő	<b>00008008992</b>

### ■ S 579-35 - fa

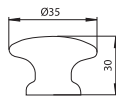

szín	cikkszám
1. lakozott bükk	<b>00008009070</b>
2. olasz alma	<b>00008009072</b>
3. lakozott juhar	<b>00008009075</b>

### ■ 059-38 - fa

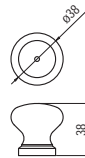

szín	cikkszám
lakozott fenyő	<b>00008009083</b>

### ■ 423-30 - fa

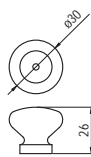

szín	cikkszám
1. lakozott bükk	<b>00008009100</b>
2. olasz alma	<b>00008009102</b>
3. lakozott juhar	<b>00008009105</b>

### ■ S 251-133 - fa

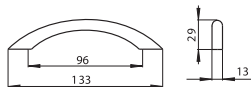
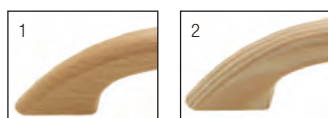

szín	cikkszám
1. lakozott bükk	<b>00008008921</b>
2. lakozott fenyő	<b>00008008922</b>



## S 251-170 - fa



szín	cikkszám
1. lakkozott bükk	<b>00008008931</b>
2. lakkozott fenyő	<b>00008008932</b>

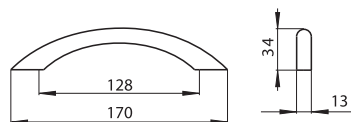
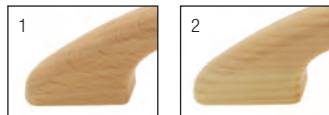

## R-1102-96 - fa

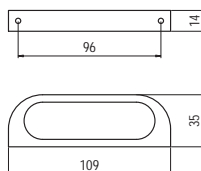

szín	cikkszám
bükk	<b>00008009310</b>

## 2358-108 - fa

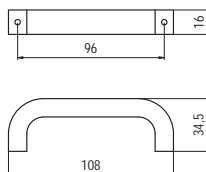

szín	cikkszám
bükk	<b>00008009330</b>

## R-0961A - fa

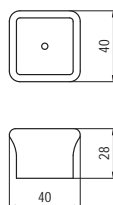

szín	cikkszám
1. tölgy	<b>00008009370</b>
2. wenge	<b>00008009371</b>

## 4.162 • Bútorfogantyúk

### ■ S 499-59 - fa

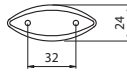

szín	cikkszám
1. lakozott bükk	<b>00008008961</b>
2. lakozott fenyő	<b>00008008962</b>

### ■ S 503-72 - fa

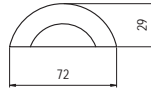
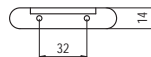

szín	cikkszám
1. lakozott bükk	<b>00008009050</b>
2. olasz alma	<b>00008009052</b>

### ■ R1567 - fa



szín	cikkszám
wenge	<b>00008009360</b>

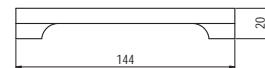
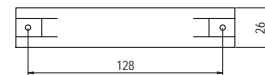

### ■ S 638-14 - fa



szín	cikkszám
wenge	<b>00008009380</b>

### ■ S 637A-20 - fa



szín	cikkszám
1. wenge	<b>00008009390</b>
2. bükk	<b>00008009391</b>
3. cseresznye	<b>00008009392</b>



## F 120-34 – F 125-34 - fa

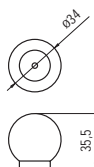

szín	cikkszám
1. F 120-34 fenyő	<b>00007901000</b>
2. F 125-34 tölgy natúr	<b>00007901200</b>

## F 150-33- fa

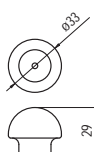

szín	cikkszám
fenyő	<b>00007902100</b>

## F 500-96 - fa

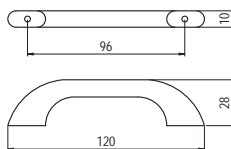

szín	cikkszám
fenyő	<b>00007902300</b>

## F 510-128 - fa



szín	cikkszám
fenyő	<b>00007902700</b>

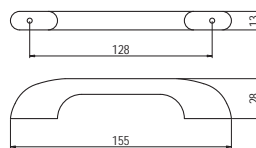

## F 605-96, F 607-96 - fa



szín	cikkszám
1. F 605-96 tölgy natúr	<b>00007905200</b>
2. F 607-96 bükk-cseresznye	<b>00007905350</b>

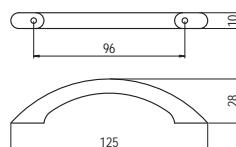



## 4.164 • Bútorfogantyúk

### F 140-35 – F 147-35 - fa

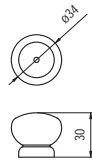

szín	cikkszám
1. F 140-35 fenyő	00007902000
2. F 144-35 bükk	00007902020
3. F 147-35 öregcseresznye	00007902050



### F 610-96 – F 619-96 - fa

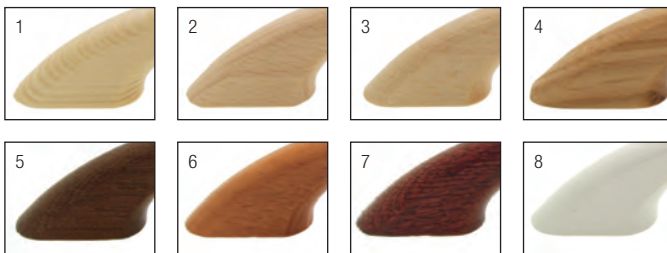

szín	cikkszám
1. F 610-96 fenyő	00007905415
2. F 613-96 nyers bükk	00007905418
3. F 614-96 bükk	00007905419
4. F 615-96 tölgy natúr	00007905420
5. F 616-96 tölgy P43 pácolt	00007905421
6. F 617-96 öregcseresznye	00007905422
7. F 618-96 tölgy mahagóni	00007905423
8. F 619-96 fehér	00007905424

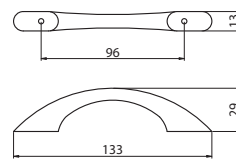

### F 620-64 – F 627-64 - fa

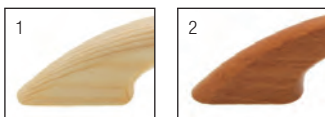
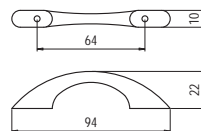

szín	cikkszám
1. F 620-64 fenyő	00007905430
2. F 627-64 öregcseresznye	00007905439

### F 160-36 – F 167-36 - fa

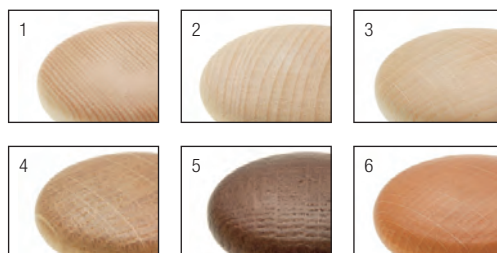
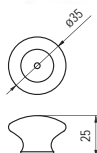

szín	cikkszám
1. F 160-36 fenyő	00007902200
2. F 163-36 nyers bükk	00007902210
3. F 164-36 bükk	00007902220
4. F 165-36 tölgy natúr	00007902230
5. F 166-36 tölgy P43 pácolt	00007902240
6. F 167-36 öregcseresznye	00007902250

## F 597-128 - fa



szín	cikkszám
bükk-cseresznye	<b>00007904930</b>

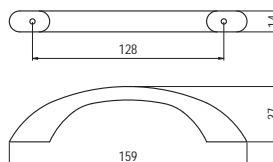

## F 640-96 – F 647-96 - fa

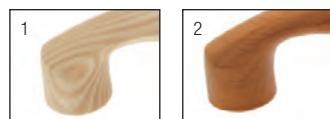

szín	cikkszám
1. F 640-96 fenyő	<b>00007905460</b>
2. F 647-96 bükk-cseresznye	<b>00007905467</b>

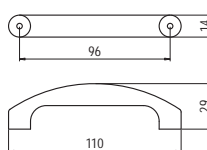

## F 110-34 – F 119-34 - fa

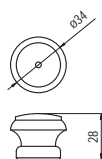

szín	cikkszám
1. F 110-34 fenyő	<b>00007900400</b>
2. F 113-34 nyers bükk	<b>00007900450</b>
3. F 114-34 bükk	<b>00007900500</b>
4. F 115-34 tölgy natúr	<b>00007900600</b>
5. F 116-34 tölgy P43 pácolt	<b>00007900700</b>
6. F 117-34 öregcsereznye	<b>00007900750</b>
7. F 118-34 tölgy mahagóni	<b>00007900800</b>
8. F 119-34 fehér	<b>00007900810</b>

## F 130-45 – F 139-45 - fa

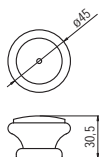

szín	cikkszám
1. F 130-45 fenyő	<b>00007901500</b>
2. F 133-45 nyers bükk	<b>00007901550</b>
3. F 134-45 bükk	<b>00007901600</b>
4. F 135-45 tölgy natúr	<b>00007901700</b>
5. F 136-45 tölgy P43 pácolt	<b>00007901800</b>
6. F 137-45 öregcsereznye	<b>00007901850</b>
7. F 138-45 tölgy mahagóni	<b>00007901900</b>
8. F 139-45 fehér	<b>00007901910</b>

## 4.166 • Bútorfogantyúk

### F 520-96 – F 526-96 - fa

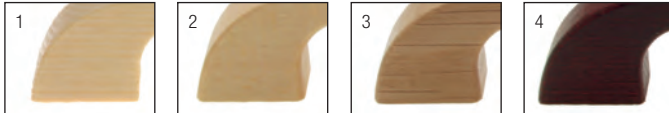

szín	cikkszám
1. F 520-96 fenyő	00007903100
2. F 524-96 bükk	00007903150
3. F 525-96 tölgy natúr	00007903200
4. F 526-96 tölgy P43 pácolt	00007903300

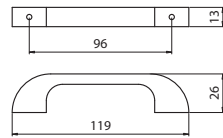

### R-0986-26 - fa / fém

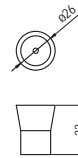

szín	cikkszám
1. nikkal - bükk	00008009260
2. matt króm - wenge	00008009261
3. matt króm - öregcseresznye	00008009262

### R-1104-128 - fa / fém



szín	cikkszám
matt króm - öregcseresznye	00008009282

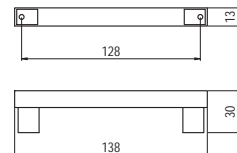

### R-0992-20 - fa / fém

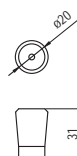

szín	cikkszám
nikkal - bükk	00008009290

## S 529-25 - fa / fém

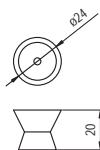

szín	cikkszám
matt króm - wenge	<b>00008009301</b>

## R-1101-160 - fa

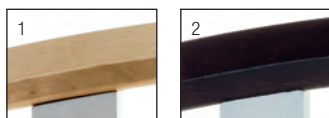
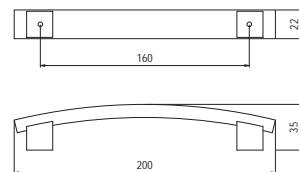

szín	cikkszám
1. bükk - szürke	<b>00008009350</b>
2. wenge - szürke	<b>00008009352</b>

## 6022-96 - fa / fém

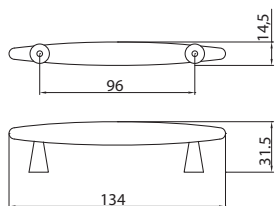
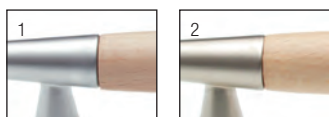

szín	cikkszám
1. bükk - matt króm	<b>00008007800</b>
2. bükk - matt nikkel	<b>00008007900</b>



## 4.168 • Bútorfogantyúk



■ **6023-128** - fa / fém



szín	cikkszám
bükk - matt króm	<b>00008008300</b>

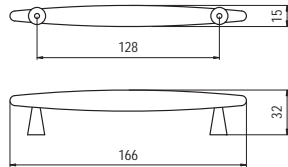

■ **6017-128** - fa / fém



szín	cikkszám
bükk - matt króm	<b>00008007200</b>

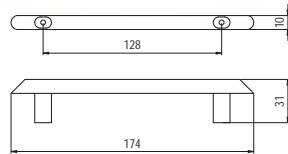

■ **8005-96** - fa / fém

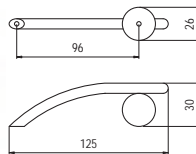

szín	cikkszám
1. bükk - matt nikkelt	<b>00008008900</b>

■ **Fogantyúcsavarok**

méret	cikkszám
M4 x 12	<b>00007100000</b>
M4 x 14	<b>00007100010</b>
M4 x 22	<b>00007100020</b>
M4 x 23	<b>00007100030</b>
M4 x 25	<b>00007100040</b>
M4 x 30	<b>00007100050</b>
M4 x 35	<b>00007100060</b>
M4 x 40	<b>00007100065</b>
M4 x 45	<b>00007100070</b>
M4 x 50	<b>00007100080</b>
M4 x 55	<b>00007100090</b>
M4 x 60	<b>00007100100</b>

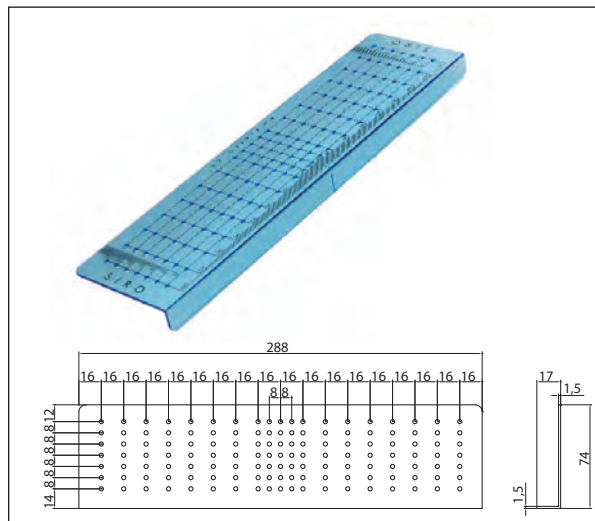

■ **H163-288**

**Furatsablon**

műanyag

**00007400000**



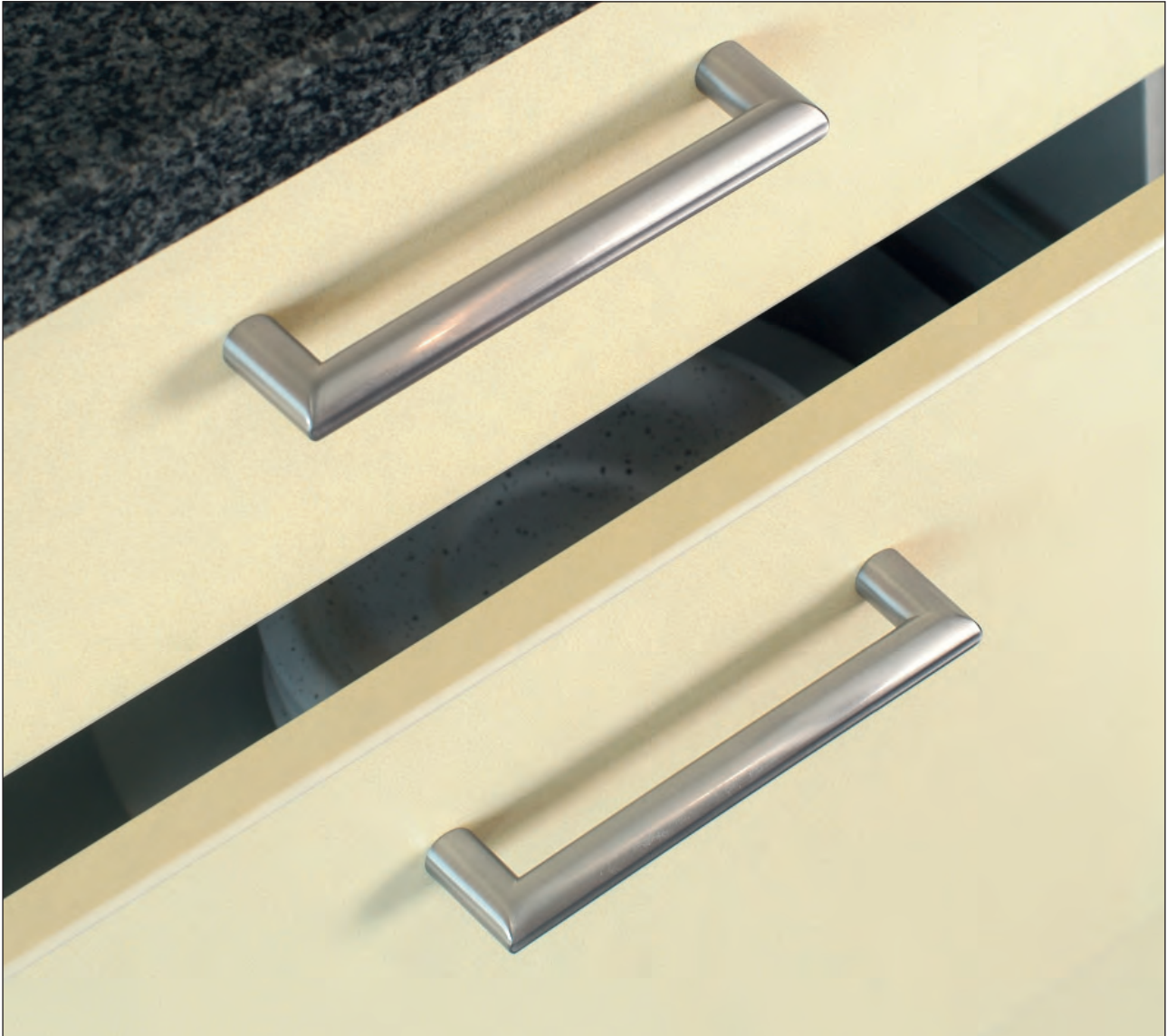

## 4.170 • Fogasok, fogassorok



**CONFALONIERI**

PA0027300 - fém

Design: Marconato & Zappa

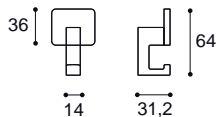

szín	cikkszám
1. Pretoria króm	00008870000
2. Botswana nikkell	00008870001
3. Patagónia ezüst	00008870002



PA0027100 - fém

Design: Bartoli Design

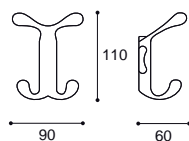

szín	cikkszám
1. Pretoria króm	00008870010
2. Botswana nikkell	00008870011
3. Patagónia ezüst	00008870012



PA0027200 - fém

Design: Marconato & Zappa

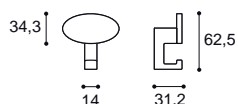

szín	cikkszám
1. Pretoria króm	00008870020
2. Botswana nikkell	00008870021
3. Patagónia ezüst	00008870022



PA0027400 - fém

Design: Bert & Bert

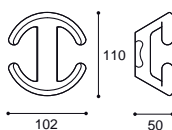

szín	cikkszám
1. Rogaland fém	00008870031
2. Patagónia ezüst	00008870032





**CONFAIÖNERI**

PA0026700 - fém

Design: Studio Dedali

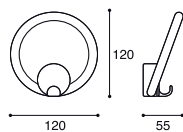

szín	cikkszám
1. Pretoria króm	00008870040
2. Botswana nikkell	00008870041
3. Patagónia ezüst	00008870042

PA0028200 - fém

Design: Bert & Bert

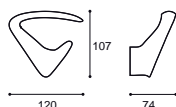

szín	cikkszám
1. Pretoria króm	00008870050
2. Botswana nikkell	00008870051
3. Patagónia ezüst	00008870052

PA0127400 - fém

Design: Bert & Bert

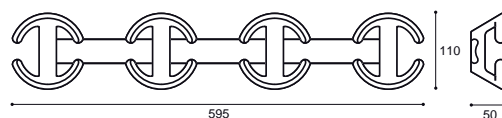

szín	cikkszám
1. Rogaland fém	00008870061
2. Patagónia ezüst	00008870062

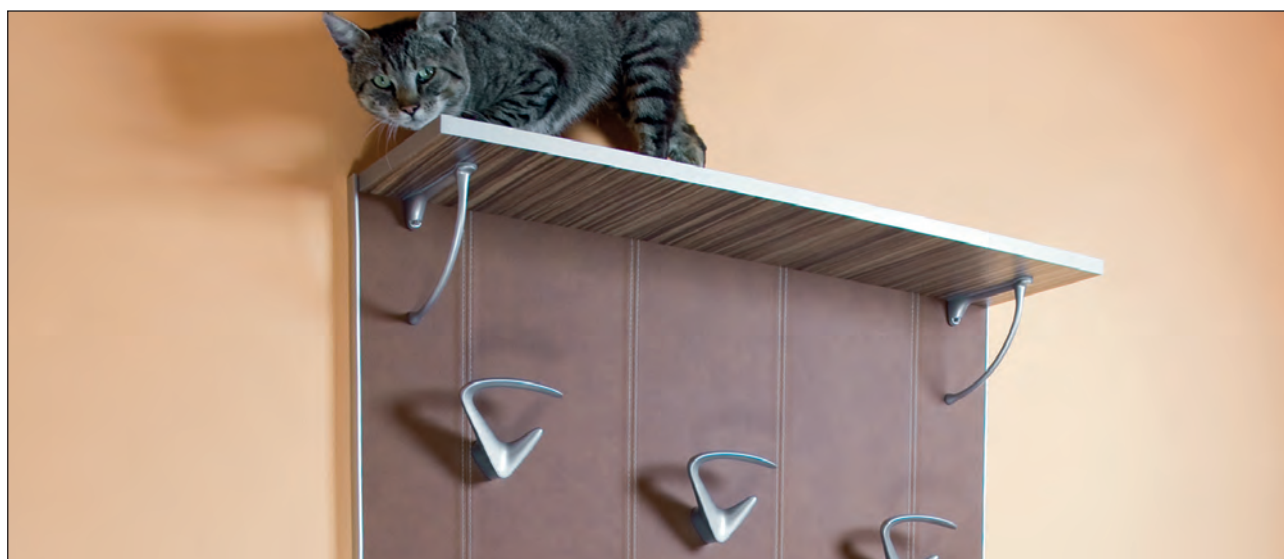



## 4.172 • Fogasok, fogassorok



CONFALONIERI

PA0027900 - fém

Design: Franco Guanzioli

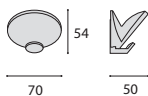

szín	cikkszám
1. botswana nikkal	00008870071
2. patagónia ezüst	00008870072

PA0027500 - fém

Design: Marconato & Zappa

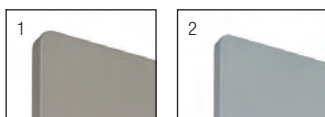
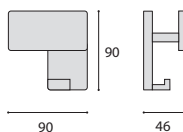

szín	cikkszám
1. botswana nikkal	00008870081
2. patagónia ezüst	00008870082

PA0027600 - fém

Design: Bert & Bert

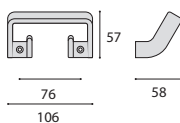

szín	cikkszám
1. botswana nikkal	00008870131
2. patagónia ezüst	00008870132





PA0028100 - fém

Design: Colombo & Vantusso

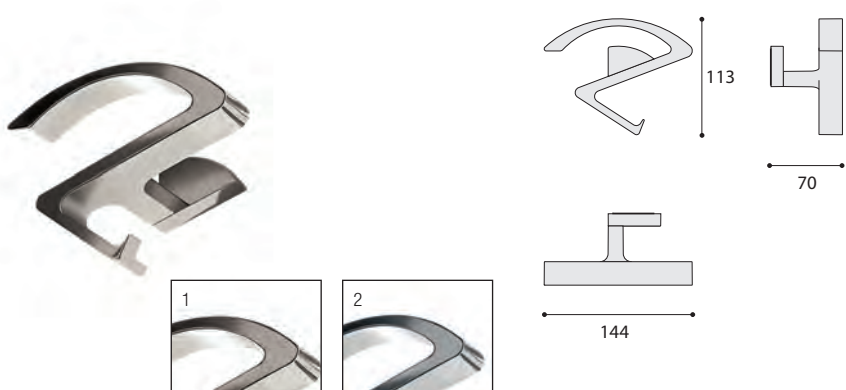

szín	cikkszám
1. botswana nikkel	00008870121
2. patagónia ezüst	00008870122

LID014800 - fém

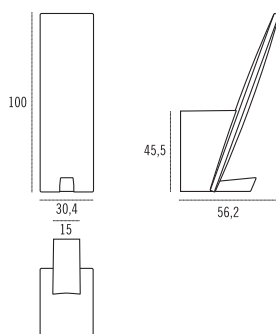

szín	cikkszám
caledonia nikkel	00008870091

LID014700 - fém

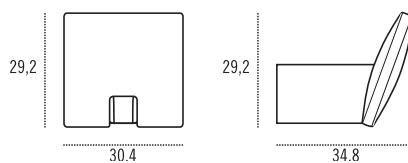

szín	cikkszám
caledonia nikkel	00008870101

LID015000 - fém

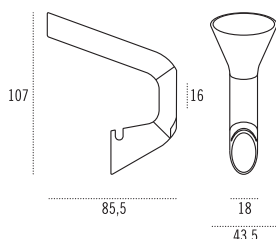

szín	cikkszám
caledonia nikkel	00008870111



## 4.174 • Fogasok, fogassorok

### 2282-42 - fém

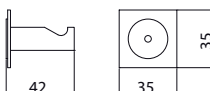
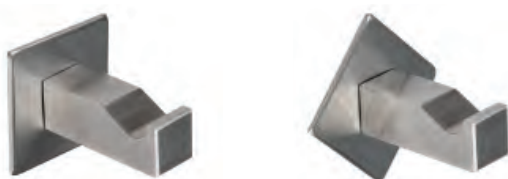

szín	cikkszám
rozsdamentes acél	<b>00008821060</b>

Így is elhelyezhető

### 1658 - fém

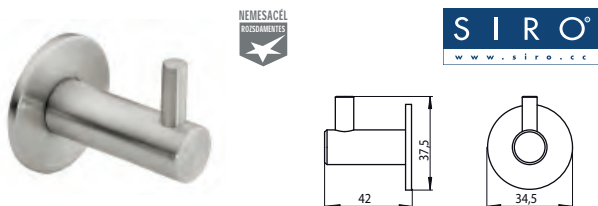

szín	cikkszám
rozsdamentes acél	<b>00008821000</b>

### 2106 - fém

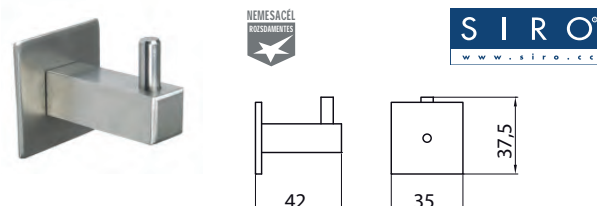

szín	cikkszám
rozsdamentes acél	<b>00008821010</b>

### 2301 - fém

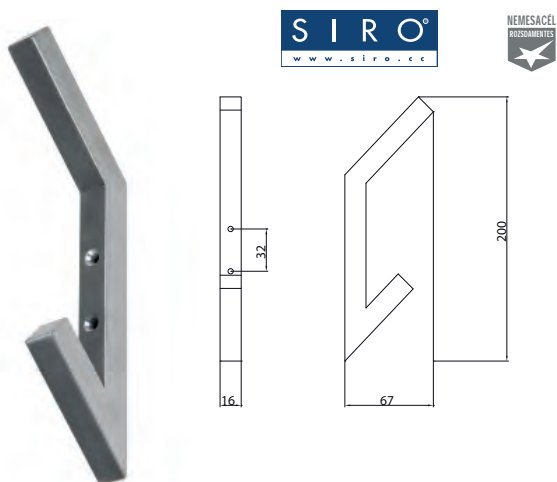

szín	cikkszám
rozsdamentes acél	<b>00008821070</b>

### 2302 - fém

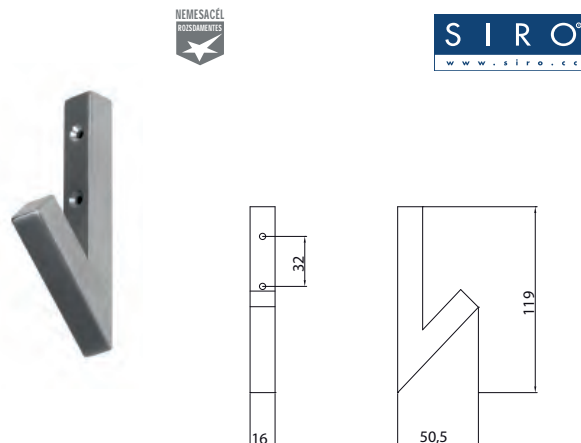

szín	cikkszám
rozsdamentes acél	<b>00008821080</b>

### E1014 - fém

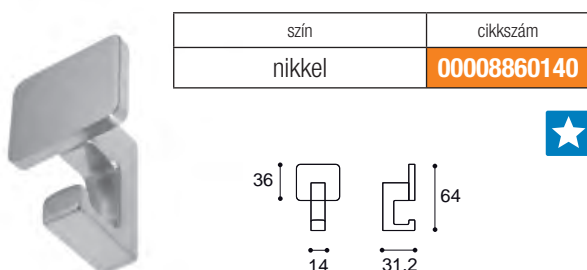

szín	cikkszám
nikkel	<b>00008860140</b>

### E1015 - fém

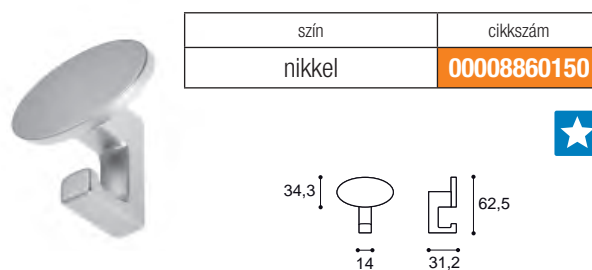

szín	cikkszám
nikkel	<b>00008860150</b>



## E1010 - fém

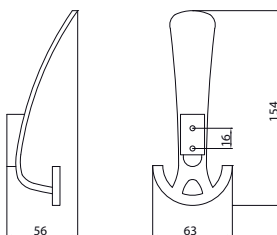

szín	cikkszám
króm - nikkell	<b>00008860100</b>

## E1011 - fém

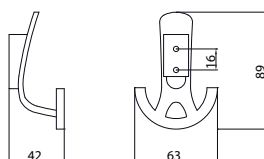

szín	cikkszám
króm - nikkell	<b>00008860110</b>

## E1013 - fém

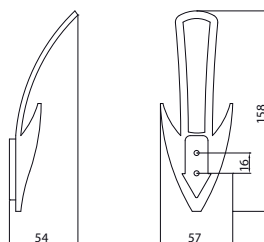

szín	cikkszám
króm - nikkell	<b>00008860130</b>

## E1012 - fém

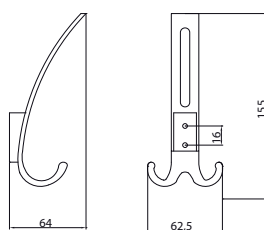

szín	cikkszám
króm - nikkell	<b>00008860120</b>

## 4.176 • Fogasok, fogassorok

### 1278 - fém

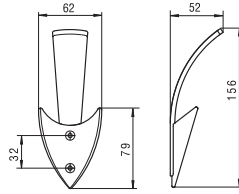

szín	cikkszám
1. króm	00008820240
2. nikkell	00008820241
3. alumínium	00008820243



### 1279 - fém

szín	cikkszám
1. króm	00008820250
2. nikkell	00008820251
3. alumínium	00008820253

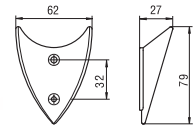

### 1282 - fém

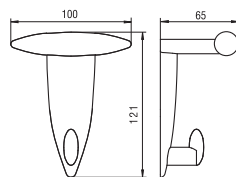

szín	cikkszám
1. króm	00008820280
2. nikkell	00008820281
3. alumínium	00008820283



## 851 - fém

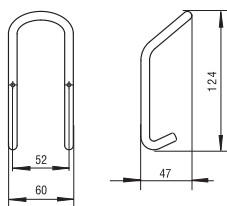

szín	cikkszám
1. króm	00008820040
2. nikkél	00008820041

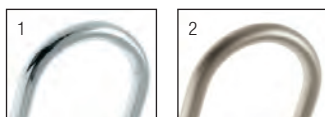

## 1280 - fém

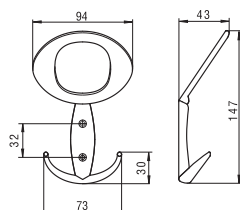

szín	cikkszám
1. króm	00008820260
2. nikkél	00008820261
3. réz	00008820262
4. alumínium	00008820263

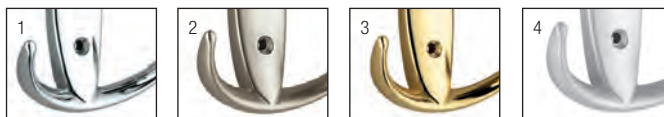

## 1281 - fém

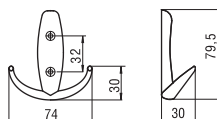

szín	cikkszám
1. króm	00008820270
2. nikkél	00008820271
3. réz	00008820272
4. alumínium	00008820273



## 1098 - fém

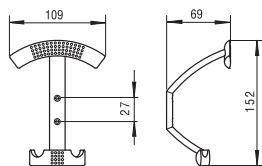

szín	cikkszám
matt króm	00008820111

## 1672 - fém

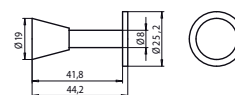

szín	cikkszám
nikkél	00008820420

## 4.178 • Fogasok, fogassorok



### ■ 2107 - fém

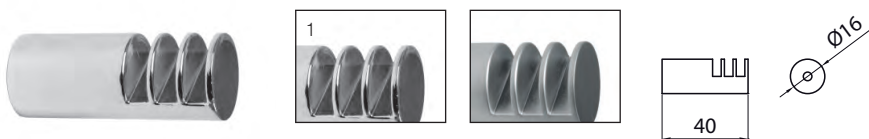

szín	cikkszám
1. króm	00008820600
2. matt króm	00008820601

### ■ 1653 - fém

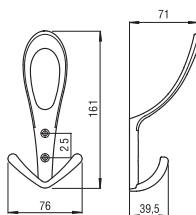

szín	cikkszám
alumínium	00008820400

### ■ 1654 - fém

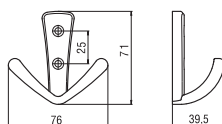

szín	cikkszám
alumínium	00008820410

### ■ 1097 - fém

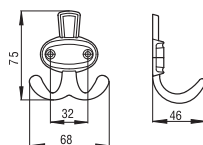

szín	cikkszám
1. króm	00008805600
2. antikolt	00008805700
3. matt króm	00008805800
4. nikkelt	00008805900
5. réz	00008806000
6. kovácsoltvas	00008806100





1096 - fém

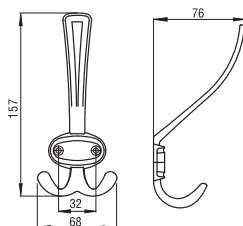

szín	cikkszám
1. króm	00008805000
2. antikolt	00008805100
3. matt króm	00008805200
4. nikkell	00008805300
5. réz	00008805400
6. kovácsoltvas	00008805500

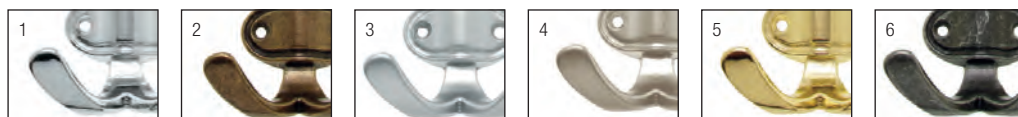

817 - fém

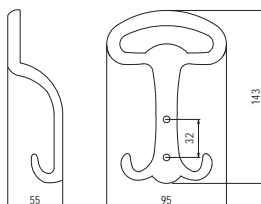

szín	cikkszám
1. króm	00008803600
2. antikolt	00008803700

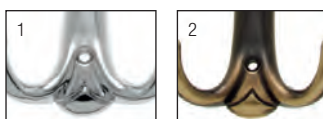

1236 - fém

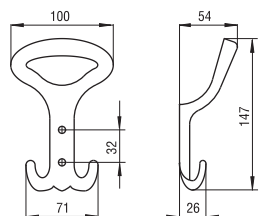

szín	cikkszám
1. króm	00008820200
2. nikkell	00008820201



1237 - fém

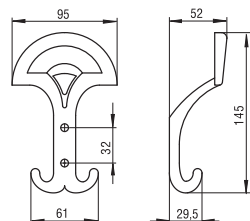

szín	cikkszám
1. króm	00008820210
2. nikkell	00008820211
3. antikolt	00008820213



## 4.180 • Fogasok, fogassorok

■ 547 - fém



szín	cikkszám
antikolt	<b>00008802100</b>

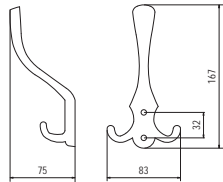

■ 548 - fém

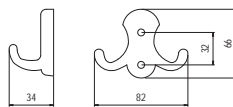

szín	cikkszám
antikolt	<b>00008802400</b>

■ 553 - fém

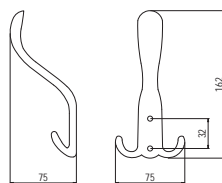

szín	cikkszám
arany	<b>00008802800</b>

■ 554 - fém

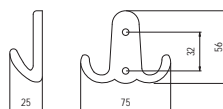

szín	cikkszám
arany	<b>00008803100</b>



■ 557 - fém



szín	cikkszám
antikolt	<b>00008803200</b>

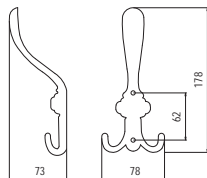

■ 558 - fém



szín	cikkszám
antikolt	<b>00008803400</b>

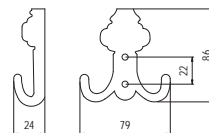

■ 1229 - fém



szín	cikkszám
antikolt ezüst	<b>00008820160</b>

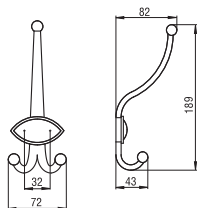

■ 1421 - fém



szín	cikkszám
1. antikolt	<b>00008820321</b>
2. matt fekete	<b>00008820322</b>

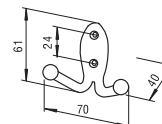
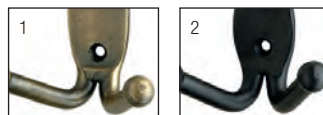

■ 1420 - fém



szín	cikkszám
1. antikolt	<b>00008820311</b>
2. matt fekete	<b>00008820312</b>

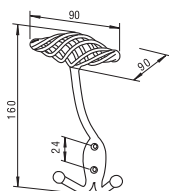
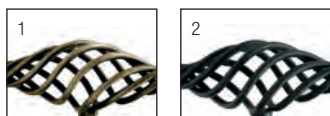

■ 1230 - fém

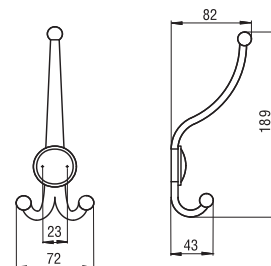

szín	cikkszám
antikolt ezüst	<b>00008820170</b>

## 4.182 • Fogasok, fogassorok

### 430 - fém

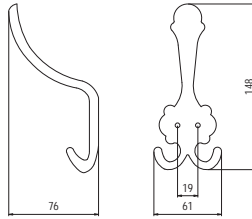
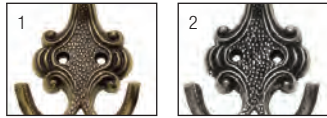

szín	cikkszám
1. antikolt	00008801460
2. kovácsoltvas	00008801465

### 431 - fém

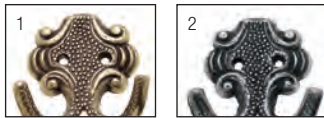

szín	cikkszám
1. antikolt	00008801470
2. kovácsoltvas	00008801475

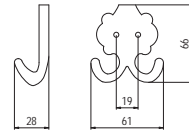

### 504 - fém



szín	cikkszám
1. króm	00008801500
2. arany	00008801700

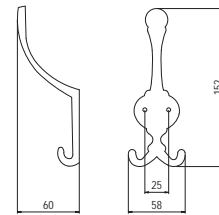

### 505 - fém



szín	cikkszám
1. króm	00008801800
2. antikolt	00008801900
3. arany	00008802000

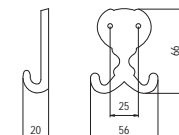



1981 - fém / műanyag

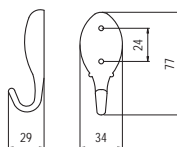

szín	cikkszám
1. króm - fehér	00008820470
2. antikolt réz - beige	00008820480

1982 - fém / műanyag

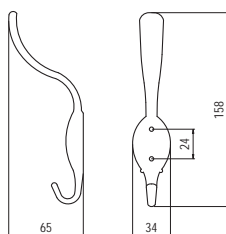

szín	cikkszám
1. króm - fehér	00008820490
2. antikolt réz - beige	00008820500

1821 - fém

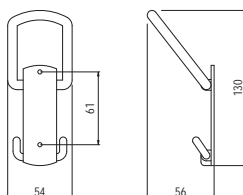

szín	cikkszám
antik réz	00008820460

2019 - fém

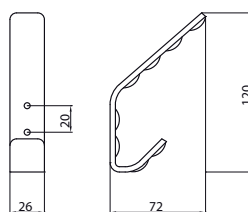

szín	cikkszám
1. antikolt ezüst	00008820540
2. antikolt réz	00008820550

2020 - fém

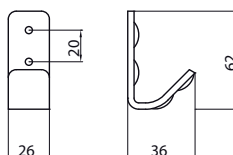

szín	cikkszám
1. antikolt ezüst	00008820560
2. antikolt réz	00008820570



## 4.184 • Fogasok, fogassorok



### T 210 - fém

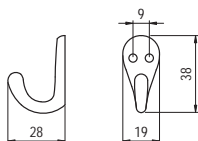

szín	cikkszám
1. fehér	00008850500
2. fekete	00008850600
3. króm	00008850700
4. réz	00008850800

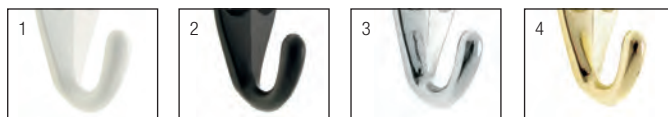

### T 211 - fém

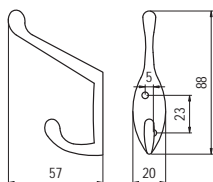

szín	cikkszám
1. fehér	00008850900
2. fekete	00008851000
3. króm	00008851100
4. réz	00008851200

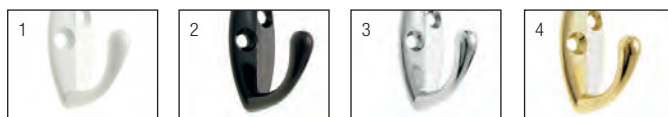

### T 212 - fém

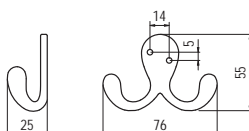

szín	cikkszám
1. króm	00008851300
2. réz	00008851400



### T 213 - fém

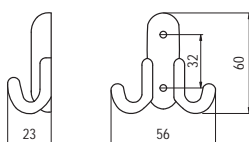

szín	cikkszám
1. fehér	00008851500
2. fekete	00008851600
3. króm	00008851700





**E1001 - fém**

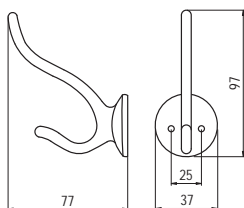

szín	cikkszám
1. króm	00008860010
2. nikkell	00008860011

**E1002 - fém**

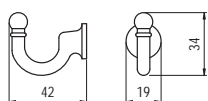

szín	cikkszám
1. króm	00008860020
2. nikkell	00008860021
3. matt króm	00008860022

**E1004 - fém**

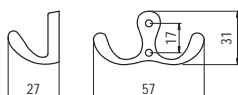

szín	cikkszám
1. króm	00008860040
2. nikkell	00008860041
3. matt króm	00008860042

**E1005 - fém**

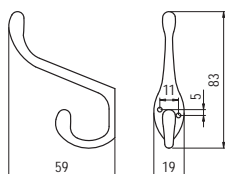

szín	cikkszám
1. króm	00008860050
2. nikkell	00008860051
3. matt króm	00008860052

**E1006 - fém**

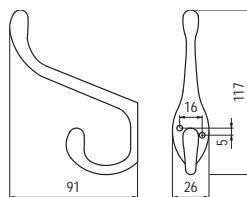

szín	cikkszám
1. króm	00008860060
2. matt króm	00008860062

## 4.186 • Fogasok, fogassorok



### E1000 - fém

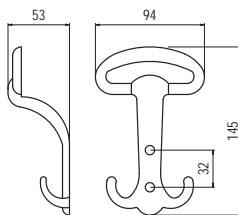
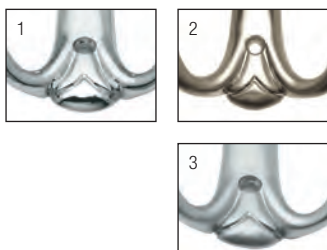

szín	cikkszám
1. króm	00008860000
2. nikkell	00008860001
3. matt króm	00008860002

### E1003 - fém

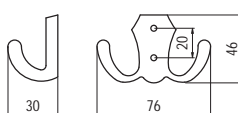
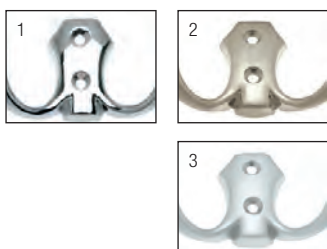

szín	cikkszám
1. króm	00008860030
2. nikkell	00008860031
3. matt króm	00008860032

### E1007 - fém

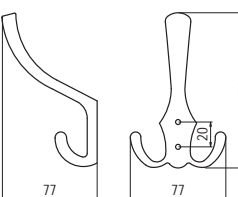
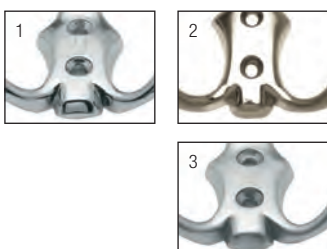

szín	cikkszám
1. króm	00008860070
2. nikkell	00008860071
3. matt króm	00008860072

### E1008 - fém

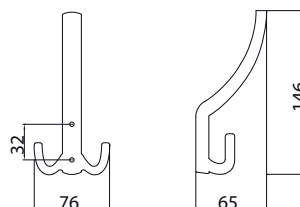
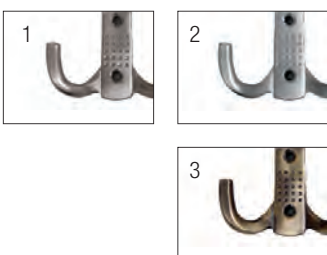

szín	cikkszám
1. nikkell	00008860081
2. matt króm	00008860082
3. fényes antikolt bronz	00008860083

### E1009 - fém

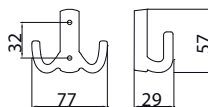
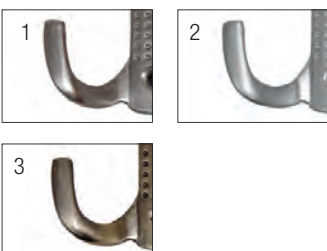

szín	cikkszám
1. nikkell	00008860091
2. matt króm	00008860092
3. fényes antikolt bronz	00008860093

EM-072-A - fém

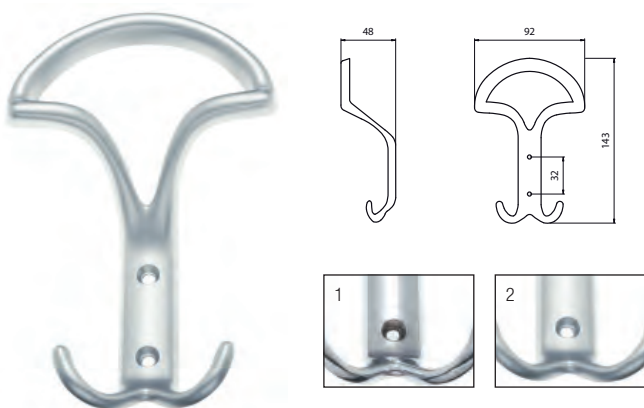

szín	cikkszám
1. króm	00008865000
2. matt króm	00008865001



EM-073-A - fém

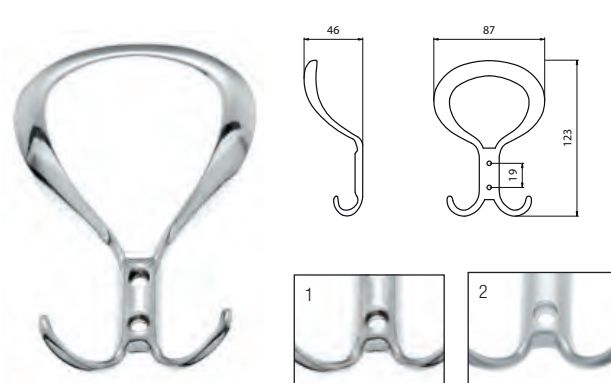

szín	cikkszám
1. króm	00008865010
2. matt króm	00008865011



743 - fém, öntapadós hátlappal



szín	cikkszám
króm	00008820700

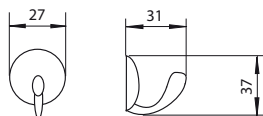

2295-121 - fém / műanyag, kihajtható



szín	cikkszám
króm -fehér	00008820690

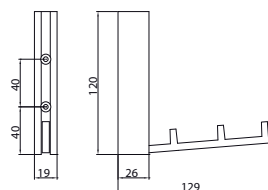

# 4.188 • Fogasok, fogassorok



0487 - műanyag

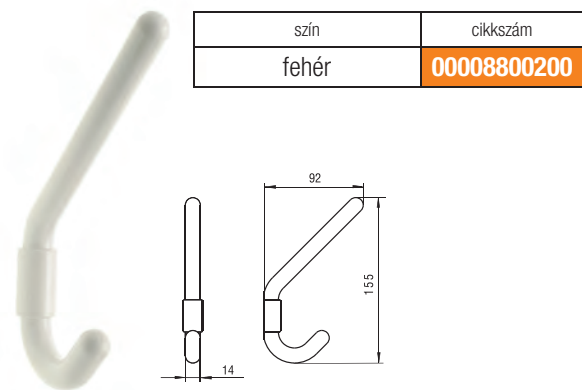

0488 - műanyag

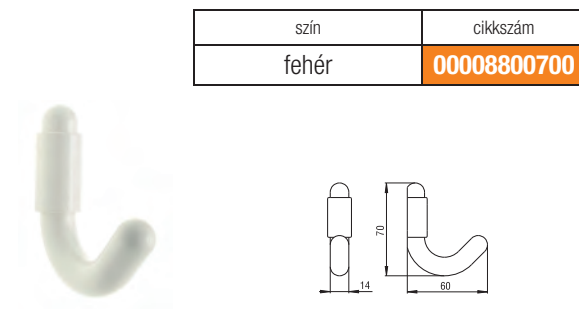

0616 - műanyag



0617 - műanyag



0557 - műanyag

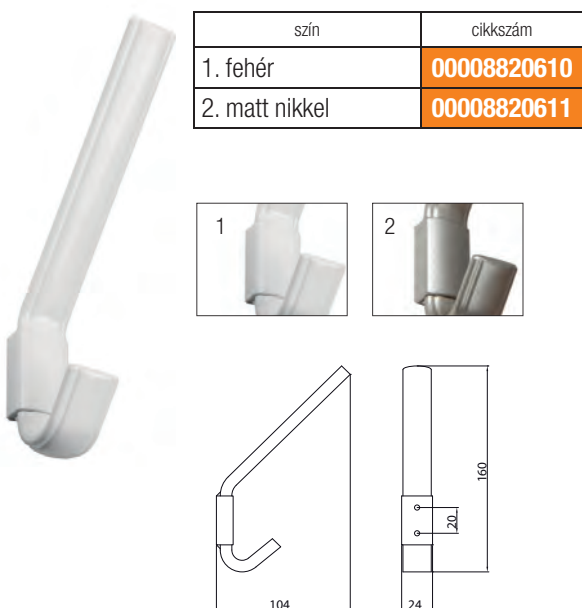

0558 - műanyag

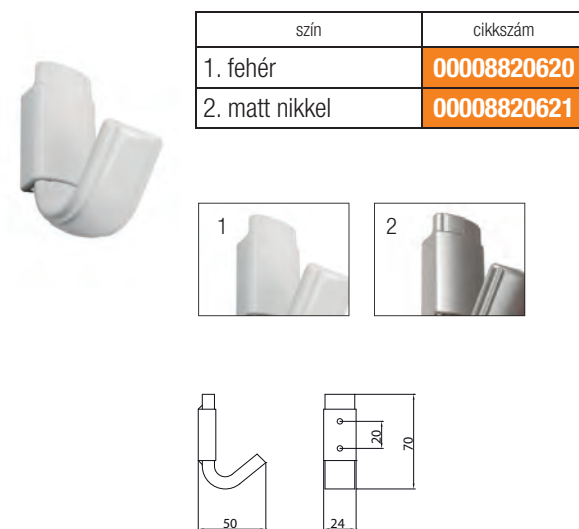





2050 - műanyag / fém

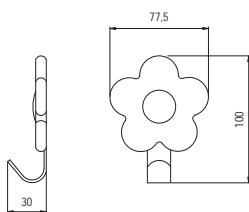

szín	cikkszám
sárga - alumínium	00008820510

2051 - műanyag / fém

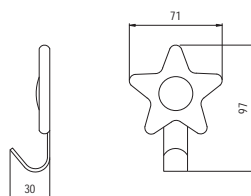

szín	cikkszám
kék - alumínium	00008820520

2052 - műanyag / fém

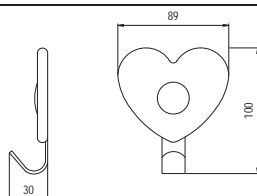

szín	cikkszám
piros - alumínium	00008820530

8165 - műanyag

Öntapadós

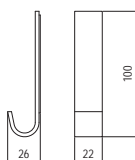

minta	cikkszám
1. vonat	00008905400
2. autó	00008905401
3. tündér	00008905402



## 4.190 • Fogasok, fogassorok

SIRO  
www.siro.cc

■ 1290-450 - fém / fa



szín	cikkszám
bükk - szürke	<b>00008904000</b>

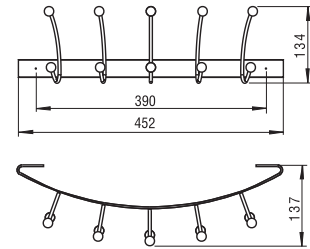

■ 1291-260 - fém / fa

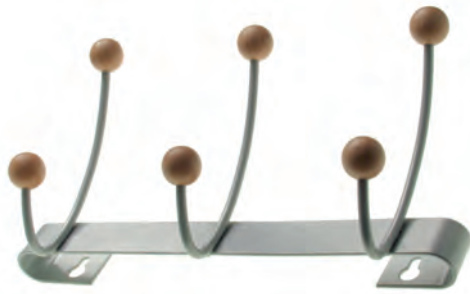

szín	cikkszám
bükk - szürke	<b>00008904010</b>

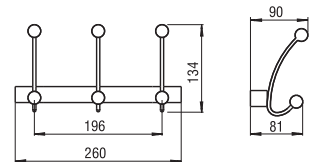

■ 1292 - fém / fa



szín	cikkszám
bükk - szürke	<b>00008904020</b>

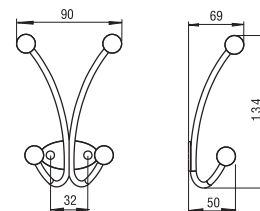

■ 1293 - fém / fa



szín	cikkszám
bükk - szürke	<b>00008904030</b>

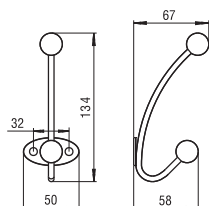

■ 1294 - fém / fa



szín	cikkszám
bükk - szürke	<b>00008904040</b>

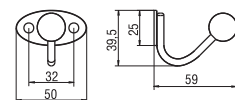



■ **2257-340** - fém, ajtóra akasztható

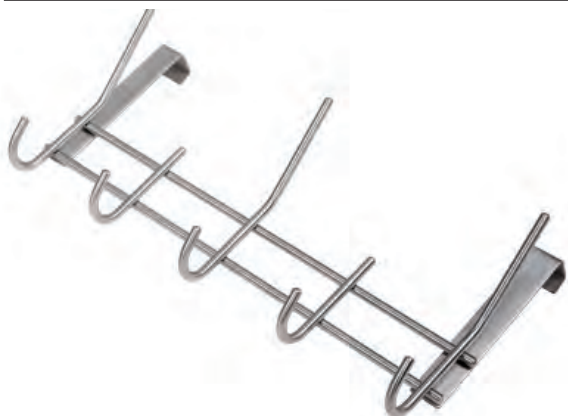

szín	cikkszám
rozsdamentes acél	<b>00008821050</b>

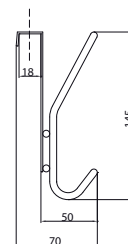
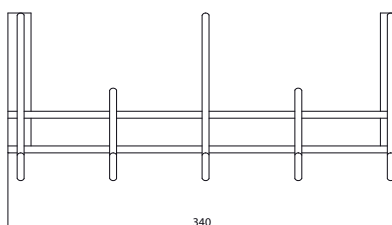

■ **2196-300** - fém



szín	cikkszám
rozsdamentes acél	<b>00008821020</b>

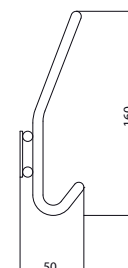
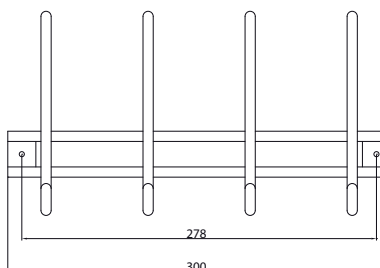

■ **2256-300** - fém



szín	cikkszám
rozsdamentes acél	<b>00008821040</b>

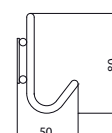
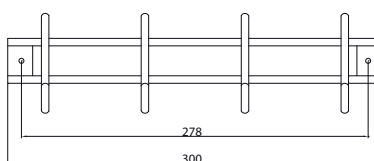

■ **2196-460** - fém

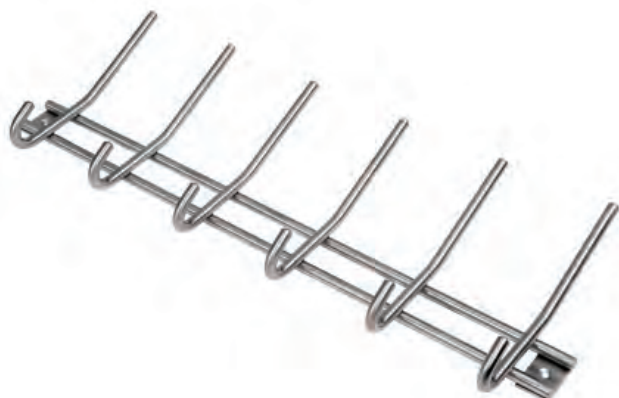

szín	cikkszám
rozsdamentes acél	<b>00008821030</b>

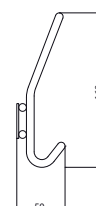
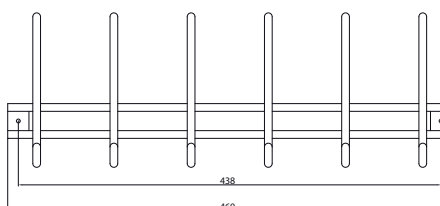

## 4.192 • Fogasok, fogassorok

■ **1977-255** - fém, ajtóra akasztható

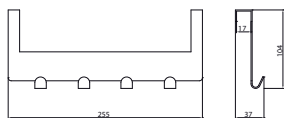

szín	cikkszám
1. króm	<b>00008820640</b>
2. matt nikkel	<b>00008820641</b>



■ **1977-375** - fém, ajtóra akasztható

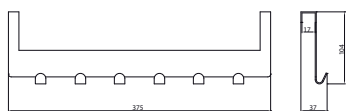

szín	cikkszám
1. króm	<b>00008820650</b>
2. matt nikkel	<b>00008820651</b>

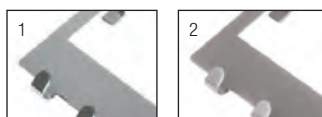

■ **2226-255** - fém, 3 különböző színes betéttel



szín	cikkszám
1. króm (labda)	<b>00008820680</b>
2. króm (lepke)	
3. króm (zene)	

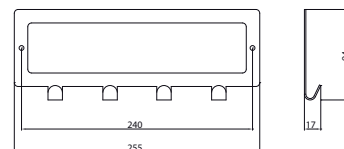

■ **2180-100** - fém, ajtóra akasztható, 3 db/csomag

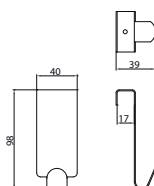

szín	cikkszám
króm	<b>00008820670</b>



1355-255 - fém

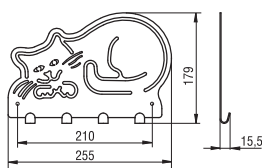

szín	cikkszám
1. króm	00008904050
2. matt nikkell	00008904051

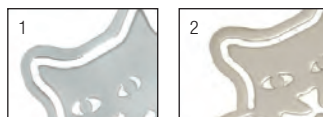

1411-255 - fém

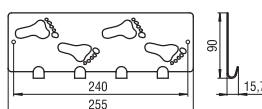

szín	cikkszám
1. króm	00008904070
2. matt nikkell	00008904071

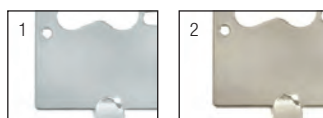

1603-240 - fém

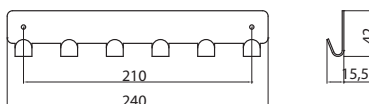

szín	cikkszám
1. króm	00008905000
2. matt nikkell	00008905010





## 4.194 • Fogasok, fogassorok



### H115-320 - műanyag

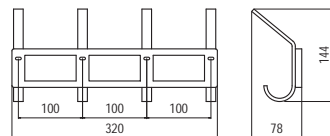

szín	cikkszám
1. fehér	00008905100
2. színes	00008905110
3. nikkell	00008905120



### H115-120 - műanyag

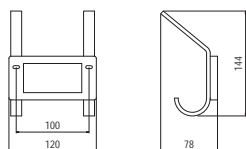

szín	cikkszám
1. fehér	00008905200
2. színes	00008905210
3. nikkell	00008905220



### 8162 - műanyag

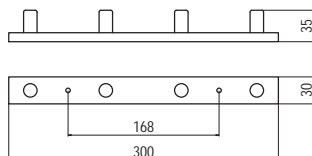
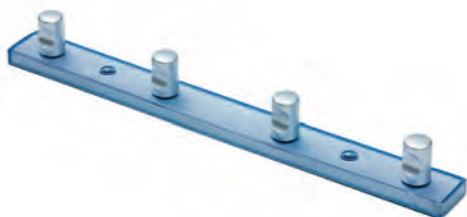

szín	cikkszám
1. színes	00008905350
2. világoskék - alu	00008905351
3. rózsaszín - alu	00008905352
4. narancs - alu	00008905353



### 8163 - műanyag

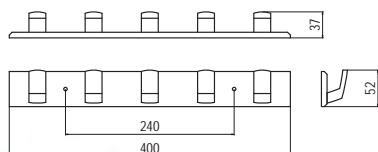

szín	cikkszám
1. m. króm - áttetsző	00008905360
2. m. króm - vil. kék	00008905361

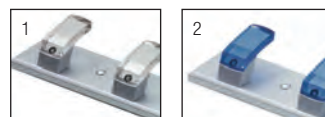

## 8161 - műanyag

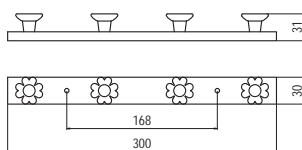

szín	cikkszám
1. kék - alu.	00008905340
2. rózsaszín - alu.	00008905341
3. narancs - alu.	00008905342



## 8167 - műanyag

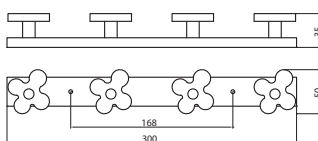

szín	cikkszám
1. rózsaszín - alu.	00008905410
2. kék - alu.	00008905411
3. narancs - alu.	00008905412

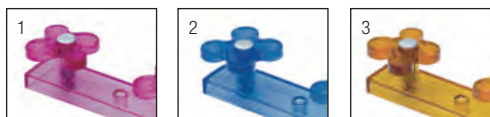

## 8168 - műanyag

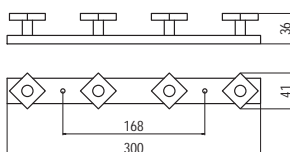

szín	cikkszám
1. kék - alu.	00008905420
2. rózsaszín - alu.	00008905421
3. narancs - alu.	00008905422



## 8170 - műanyag



szín	cikkszám
fekete bőrh. - króm	00008905430

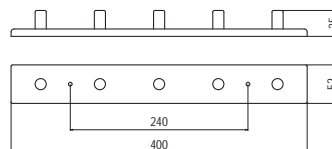

## 8171 - műanyag

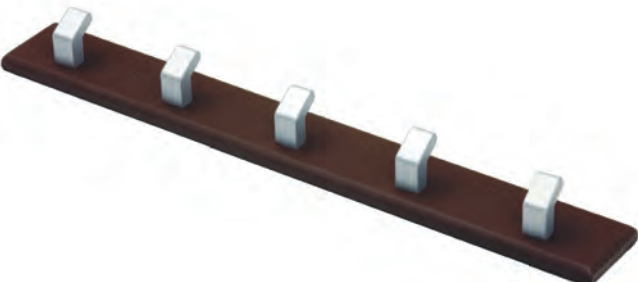

szín	cikkszám
barna bőrh. - alu.	00008905440

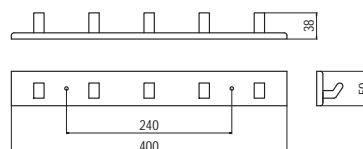

## 4.196 • Fogasok, fogassorok

### R-1270-400 - fa / műanyag

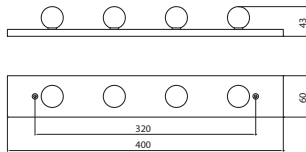

szín	cikkszám
zöld	<b>00008905330</b>

### 8164 - műanyag

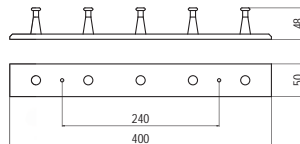

szín	cikkszám
1. fehér - króm	<b>00008905370</b>
2. matt króm - króm	<b>00008905371</b>
3. wenge - króm	<b>00008905372</b>
4. vonat	<b>00008905380</b>
5. autó	<b>00008905381</b>
6. tündér	<b>00008905382</b>



### 8177 - műanyag

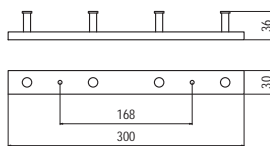
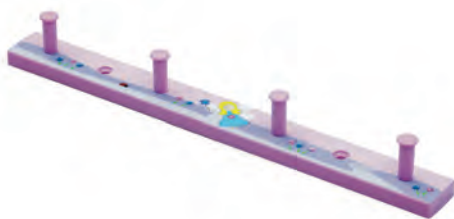

szín	cikkszám
1. vonat	<b>00008905390</b>
2. autó	<b>00008905391</b>
3. tündér	<b>00008905392</b>

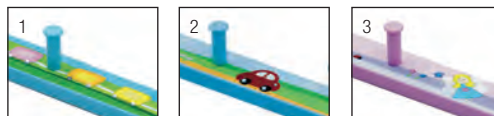



## S666-440 - fa / fém

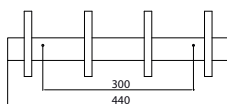
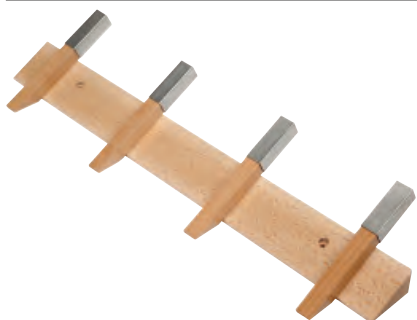

szín	cikkszám
fehér	00008904230
natúr	00008904231
wenge	00008904232

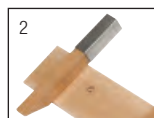

## 1674-550 - fém

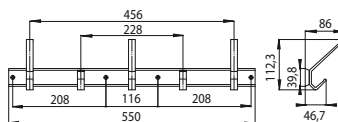
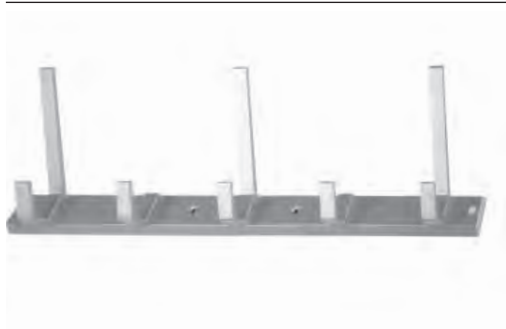

szín	cikkszám
alumínium	00008820630

## 2081 DM-272 - fém

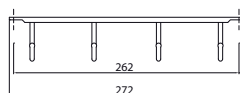
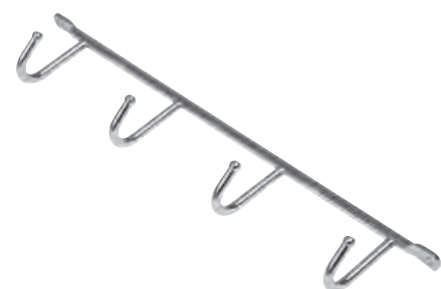

szín	cikkszám
króm	00008820660

## 4.198 • Fogasok, fogassorok



### R0658-390

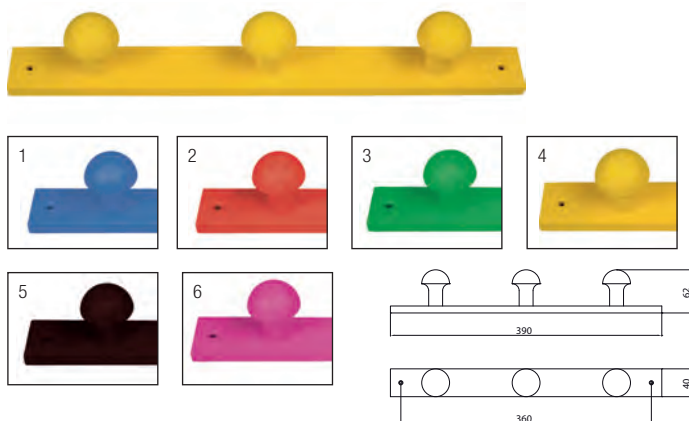

szín	cikkszám
1. kék	00008904200
2. piros	00008904201
3. zöld	00008904202
4. sárga	00008904203
5. wenge	00008904204
6. rózsaszín	00008904205

### R0658-520

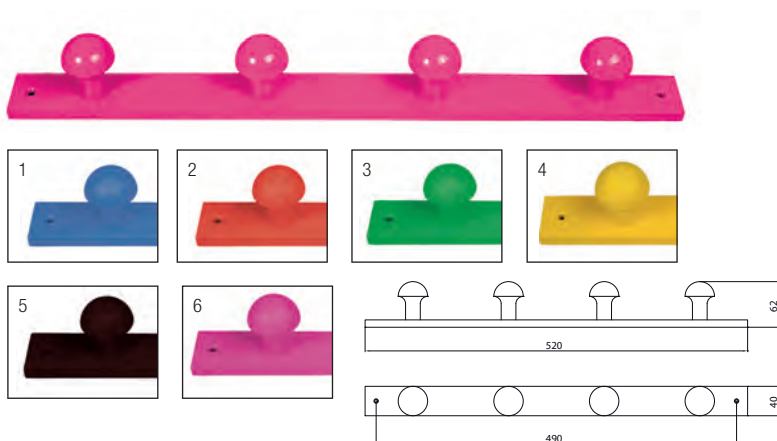

szín	cikkszám
1. kék	00008904210
2. piros	00008904211
3. zöld	00008904212
4. sárga	00008904213
5. wenge	00008904214
6. rózsaszín	00008904215

### LW0006-390

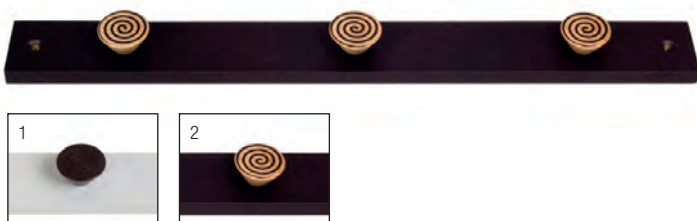

szín	cikkszám
fehér sín - wenge fogas	00008904220
wenge sín - natúr fogas	00008904221

### S 641-420 - fa

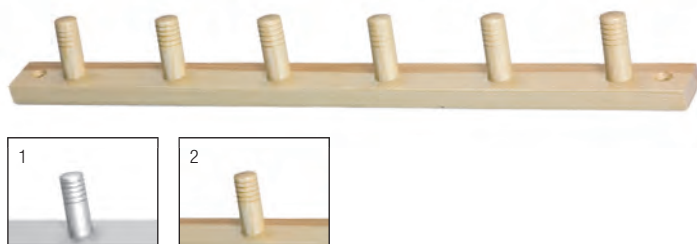

szín	cikkszám
1. alumínium	00008905300
2. fenyő	00008905301

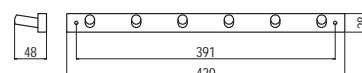



## S 641-280 - fa

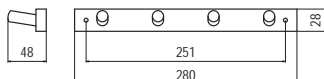

szín	cikkszám
1. fenyő	00008905310
2. alumínium	00008905311



## S 592-420 - fa

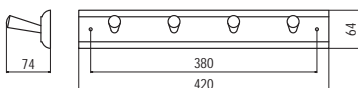

szín	cikkszám
1. fenyő	00008905320
2. alumínium	00008905321



## 300 - fa

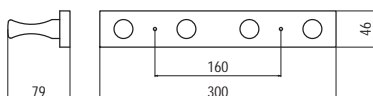

szín	cikkszám
1. olasz alma	00008903419
2. bükk-cseresznye	00008903421
3. bükk	00008903433

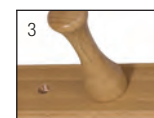
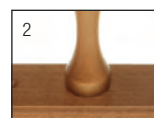

## 220 - fa

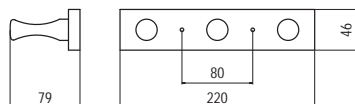

szín	cikkszám
1. olasz alma	00008903423
2. bükk-cseresznye	00008903425
3. bükk	00008903431



## 380 - fa

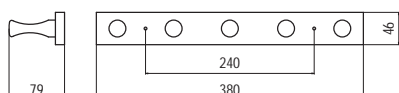

szín	cikkszám
1. olasz alma	00008903427
2. bükk-cseresznye	00008903429
3. bükk	00008903435
4. fehér	00008903459

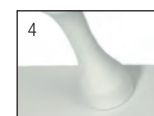
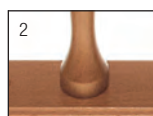

## 4.200 • Fogasok, fogassorok

■ 362 - fa



szín	cikkszám
fenyő	<b>00008903470</b>

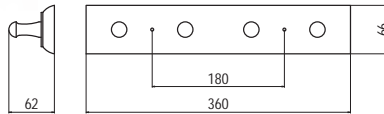

■ 450 - fa



szín	cikkszám
fenyő	<b>00008903475</b>

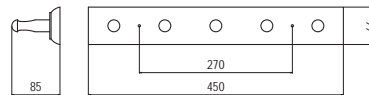

■ 380 - fa / fém



szín	cikkszám
1. fehér	<b>00008903505</b>

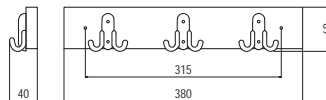

■ 450 - fa / fém



szín	cikkszám
1. fehér	<b>00008903530</b>
2. fekete	<b>00008903585</b>

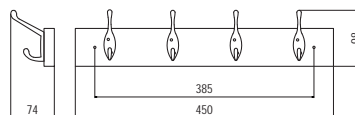

■ 300 - fa / fém



szín	cikkszám
1. fehér	<b>00008903589</b>
2. fehér - réz	<b>00008903591</b>

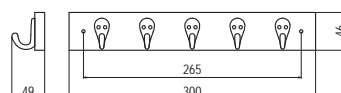

Cikkszám	Típus	Oldal
00000652200	L806A	4.3
00000652210	L807A	4.3
00000652220	L808A	4.3
00007100000	CSAVAR	4.168
00007100010	CSAVAR	4.168
00007100020	CSAVAR	4.168
00007100030	CSAVAR	4.168
00007100040	CSAVAR	4.168
00007100050	CSAVAR	4.168
00007100060	CSAVAR	4.168
00007100065	CSAVAR	4.168
00007100070	CSAVAR	4.168
00007100080	CSAVAR	4.168
00007250010	H 022-56 TEKNŐSBÉKA	4.133
00007250013	H 023-55 TENGERI CSILLAG	4.134
00007250016	H 024-65 CSIKÓHAL	4.133
00007250019	H 025-57 HAL	4.133
00007250022	H 026-61 HAL	4.133
00007250025	H 027-57 HAL	4.133
00007250031	H 029-52 TENGERI CSIGA	4.133
00007250050	H 039-44 LEPKE	4.132
00007250060	H 040-40 LEPKE	4.132
00007250070	H 041-42 LEPKE	4.132
00007250090	H 049-41 LEPKE	4.132
00007250151	H 061-49 CSIL- LAG	4.134
00007250200	H 069-45 DONGÓ	4.131
00007250290	H 125-50 A55 VIRÁG	4.134
00007250310	H 127-38 A58 VIRÁG	4.134
00007250311	H 127-38 A59 VIRÁG	4.134
00007250320	H147-47 RU1 AUTÓ	4.131
00007250330	H148-40 RU2 FOCILABDA	4.131
00007250340	H149-44 RU3 SÁRGA VIRÁG	4.132
00007250341	H149-44 RU4 KÉK VIRÁG	4.132
00007250342	H149-44 RU5 RÓZSASZÍN VIRÁG	4.132
00007250350	H150-53 RU6 BOHÓCHAL	4.131
00007250360	H152-44 RU8 CSIGA	4.131
00007250400	H156-40 RU12 NÉGYZET	4.131
00007250410	H157-50 RU13 SZINES CSILLAG	4.131
00007250420	H158-51 RU14 CICA	4.131
00007250430	H159-50 RU15 BÉKA	4.131

Cikkszám	Típus	Oldal
00007250440	1882-56 ZN50 REPÜLŐ	4.130
00007250450	1883-109 ZN50 KISVONAT	4.130
00007250460	1884-48 ZN50 VITORLÁS	4.130
00007250470	1885-56 ZN50 KUTYA	4.130
00007250480	1886-36 ZN50 MACSKA	4.130
00007250491	1887-41 ZN50 PÓLÓ	4.130
00007250501	1888-40 ZN50 NADRÁG	4.130
00007250510	01022-153 VILÁGÍTÓ TORONY	4.135
00007250520	01023-34 KOR- MÁNYKERÉK	4.135
00007255010	MT 1317-26	4.52
00007255013	MT 1317-26	4.52
00007255015	MT 1317-26	4.52
00007255019	MT 1318-121	4.52
00007255021	MT 1318-121	4.52
00007255023	MT 1319-94	4.52
00007255025	MT 1319-94	4.52
00007255027	MT 1319-94	4.52
00007255029	MT 1301-82	4.52
00007255031	MT 1301-82	4.52
00007255033	MT 1301-82	4.52
00007255035	MT 1320-123	4.201
00007255037	MT 1320-123	4.201
00007255039	MT 1320-123	4.201
00007300028	1021-146	4.84
00007300036	1021-146	4.84
00007300052	1029-147	4.53
00007300056	1029-147	4.53
00007300100	1095-90	4.69
00007300200	1095-90	4.69
00007303651	397-23	4.91
00007303661	397-35	4.91
00007303681	398-70	4.91
00007303691	398-98	4.91
00007303800	885-208	4.13
00007303810	885-240	4.13
00007303820	885-320	4.13
00007303830	885-368	4.13
00007303840	885-416	4.13
00007303850	885-512	4.13
00007303860	885-559	4.13
00007303870	885-635	4.13
00007303880	885-688	4.13
00007303890	885-816	4.13
00007303900	885-863	4.13
00007303910	885-1449	4.13
00007303950	1209-30	4.83

Cikkszám	Típus	Oldal
00007303960	1209-40	4.83
00007303970	1210-106	4.83
00007303980	1210-126	4.83
00007304140	1253-180	4.49
00007304141	1253-180	4.49
00007304142	1253-180	4.49
00007304143	1253-180	4.49
00007304171	1268-51	4.82
00007304172	1268-51	4.82
00007304180	1268-62	4.82
00007304181	1268-62	4.82
00007304182	1268-62	4.82
00007304191	1303-34	4.82
00007304210	1304-104	4.82
00007304211	1304-104	4.82
00007304212	1304-104	4.82
00007304221	1304-136	4.82
00007304222	1304-136	4.82
00007304241	1340-134	4.69
00007304261	1342-134	4.69
00007304270	1368-33	4.83
00007304280	1368-42	4.83
00007304480	1520-59	4.20
00007304481	1520-59	4.20
00007304490	1536-122	4.92
00007304510	1538-152	4.41
00007304550	1546-137	4.91
00007304551	1546-137	4.91
00007304560	1548-18	4.92
00007304570	1549-50 alátét	4.92
00007304710	1597-52	4.20
00007304740	1651-113	4.20
00007304760	1652-35	4.20
00007304770	0990-146 MT1K1P	4.201
00007304771	0990-146 MV11K1P	4.201
00007304780	0991-30 MT1K1P	4.201
00007304781	0991-30 MV11K1P	4.201
00007304810	0994-146 MT1K1P	4.201
00007304811	0994-146 MV11K1P	4.201
00007304820	0951-136 MV11	4.201
00007304842	01006-36 K19	4.201
00007304844	01006-36 MT3	4.201
00007304850	1360-40 ZN2K- GSU1	4.201
00007304851	1360-40 ZN2K- GSU2	4.201
00007304855	1360-113 ZN2KGSU1	4.201
00007304856	1360-113 ZN2KGSU2	4.201

Cikkszám	Típus	Oldal
00007304881	1582-118 ZN1KGSAC3	4.201
00007304910	1809-110 ZN21	4.42
00007304911	1809-110 ZN1	4.42
00007304920	1816-44 ZN21	4.93
00007304921	1816-44 ZNS5	4.93
00007304925	1816-69 ZN21	4.93
00007304926	1816-69 ZNS5	4.93
00007304931	1896-23 ZN31A78	4.201
00007304935	1896-30 ZN1A4	4.126
00007304936	1896-30 ZN31A78	4.126
00007304940	1897-32 ZN1A4	4.126
00007304941	1897-32 ZN31A78	4.126
00007304950	1898-106 ZN1A4	4.126
00007304951	1898-106 ZN31A78	4.126
00007304956	1898-138 ZN31A78	4.126
00007304960	1916-136 ZN29	4.94
00007305010	1969-68 ZN31	4.92
00007305020	1970-68 ZN31	4.92
00007305040	1972-32 ZN31A78	4.201
00007305050	1973-106 ZN31A78	4.127
00007305055	1973-138 ZN31A78	4.127
00007305080	2040-20 ZN21J3	4.42
00007305081	2040-20 PB21J3	4.42
00007305090	2038-110 ZN21J3	4.42
00007305091	2038-110 PB21J3	4.42
00007305100	2038-142 ZN21J3	4.42
00007305101	2038-142 PB21J3	4.42
00007305150	2113-168 ZN1	4.38
00007305170	2057-75 ZN1	4.40
00007305180	2108-168 ZN21	4.40
00007305190	2120-136 ZN1	4.41
00007305200	2029-19 ZN10	4.95
00007306000	1197-110	4.87
00007306100	1197-110	4.87
00007306200	1198-147	4.87
00007306300	1198-147	4.87
00007306310	1889-67	4.127
00007306320	1881-130	4.127
00007306330	1700-29	4.127
00007306331	1700-29	4.127
00007306340	1699-107	4.127
00007306341	1699-107	4.127
00007306350	1986-44 ZN29	4.94
00007306351	1986-44 ZN31	4.94
00007306352	1986-44 ZN1	4.94

## 4.202 • Bútorfogantyúk és fogasok • Cikkszám táblázat

Cikkszám	Típus	Oldal
00007306362	1987-108 ZN1	4.94
00007306370	1987-140 ZN29	4.95
00007306371	1987-140 ZN31	4.95
00007306372	1987-140 ZN1	4.95
00007306380	1818-30 ZN31	4.92
00007306390	1984-30 ZN31	4.95
00007306400	1985-145 ZN31	4.95
00007306410	1974-18 ZN31	4.94
00007306450	2032-36 ZN29	4.79
00007306451	2032-36 ZN31	4.79
00007306460	2033-165 ZN29	4.79
00007306461	2033-165 ZN31	4.79
00007306480	2015-54 ZN28JE4	4.80
00007306481	2015-54 ZN31JE4	4.80
00007306500	1696-335 ZN10	4.80
00007306510	1697-376 ZN10	4.80
00007306520	1874-365 ZN10	4.81
00007306530	2006-91 ZN10	4.79
00007306531	2006-91 ZN29	4.79
00007306560	2076-24 ZN10	4.81
00007306561	2075-93 ZN10	4.81
00007306570	2026-40 ZN1	4.81
00007306571	2026-40 ZN10	4.81
00007306590	2039-38 ZN10	4.81
00007306600	2035-72 ZN1	4.41
00007306601	2035-72 ZN21	4.41
00007306610	2035-232 ZN1	4.41
00007306611	2035-232 ZN21	4.41
00007306620	2092-65 PB21	4.41
00007306630	2129-112 ZN10	4.95
00007306640	2182-118 ZN1	4.39
00007306641	2182-118 ZN21	4.39
00007306650	2182-182 ZN1	4.39
00007306651	2182-182 ZN21	4.39
00007306660	2182-342 ZN1	4.39
00007306661	2182-342 ZN21	4.39
00007306670	2183-104 ZN1	4.40
00007306671	2183-104 ZN21	4.40
00007306680	2183-168 ZN1	4.40
00007306681	2183-168 ZN21	4.40
00007306690	2183-328 ZN1	4.40
00007306691	2183-328 ZN21	4.40
00007306700	2113-137 ZN1	4.38
00007306701	2113-137 ZN21	4.38
00007306710	2110-252 ZN1	4.40
00007306720	2110-284 ZN1	4.40
00007306730	2110-348 ZN1	4.40
00007306770	2198-173 ZN1	4.39
00007306771	2198-173 ZN21	4.39
00007306780	2198-333 ZN1	4.39
00007306781	2198-333 ZN21	4.39

Cikkszám	Típus	Oldal
00007306790	2184-137 ZN1GH2	4.38
00007306791	2184-137 ZN21GH1	4.38
00007306800	2184-200 ZN1GH2	4.38
00007306801	2184-200 ZN21GH1	4.38
00007310000	1585-143 N1	4.12
00007310010	1585-175 N1	4.12
00007310020	1585-207 N1	4.12
00007310030	1585-335 N1	4.12
00007310040	902-24 N1	4.11
00007310050	904-12 N1	4.11
00007310060	1404-18 N1	4.11
00007310100	901-74 N1	4.12
00007310110	901-106 N1	4.12
00007310120	901-138 N1	4.12
00007310130	901-170 N1	4.12
00007310200	1406-108 N1	4.11
00007310210	1406-140 N1	4.11
00007310220	1406-172 N1	4.11
00007310300	1407-148 N1	4.12
00007310310	1407-184 N1	4.12
00007310320	1407-216 N1	4.12
00007310330	1407-248 N1	4.12
00007310340	1407-344 N1	4.12
00007310350	2277-10 N1	4.11
00007310360	2279-18 N1	4.11
00007400000	JELŐLŐSABLON	4.168
00007401200	0287-106	4.154
00007404000	0548-38	4.153
00007404200	0549-134	4.152
00007404220	0549-134	4.152
00007404240	0549-134	4.152
00007404260	0549-134	4.152
00007404280	0549-134	4.152
00007404282	0549-134	4.152
00007404284	0549-134	4.152
00007404286	0549-134	4.152
00007404290	0549-134	4.152
00007404300	0549-134	4.152
00007404900	0549-97	4.153
00007404920	0549-97	4.153
00007404940	0549-97	4.153
00007404960	0549-97	4.153
00007404970	0549-97	4.153
00007405000	0549-97	4.153
00007408500	0618-64	4.147
00007408600	0618-64	4.147
00007409630	356-97	4.90
00007409650	479-106	4.84
00007409660	495-112	4.90

Cikkszám	Típus	Oldal
00007409672	563-105	4.84
00007410230	812-86	4.89
00007410235	812-120	4.89
00007410600	873-28	4.50
00007410700	873-28	4.50
00007410800	873-28	4.50
00007410900	873-28	4.50
00007411000	873-28	4.50
00007411100	878-128	4.50
00007411200	878-128	4.50
00007411300	878-128	4.50
00007411400	878-128	4.50
00007411500	878-128	4.50
00007411510	878-160	4.50
00007411520	878-160	4.50
00007411530	878-160	4.50
00007411550	1313-130	4.49
00007411551	1313-130	4.49
00007411552	1313-130	4.49
00007411560	1314-20	4.49
00007411561	1314-20	4.49
00007411562	1314-20	4.49
00007411572	1309-116	4.49
00007411600	908-110	4.53
00007411700	908-110	4.53
00007411800	908-110	4.53
00007412300	911-72	4.53
00007412400	911-72	4.53
00007412500	911-72	4.53
00007412600	912-73	4.51
00007412700	912-73	4.51
00007412800	913-32	4.70
00007412900	913-32	4.70
00007413000	914-102	4.53
00007413100	914-102	4.53
00007413200	914-102	4.53
00007413700	916-135	4.53
00007413805	916-135	4.53
00007414200	918-38	4.70
00007414500	919-30	4.70
00007414600	919-30	4.70
00007414700	920-28	4.87
00007414800	920-28	4.87
00007414900	920-28	4.87
00007415000	921-127	4.87
00007415100	921-127	4.87
00007415200	921-127	4.87
00007415300	921-127	4.87
00007415400	922-113	4.89
00007415500	922-113	4.89
00007415600	923-101	4.51
00007415700	923-101	4.51

Cikkszám	Típus	Oldal
00007415800	924-108	4.89
00007415900	924-108	4.89
00007416400	932-16	4.51
00007416600	932-16	4.51
00007416720	941-107	4.51
00007416800	947-102	4.90
00007417000	947-86	4.90
00007417100	947-86	4.90
00007418200	959-45	4.90
00007418300	959-45	4.90
00007418700	969-46 KULCSCIM	4.94
00007418800	969-46 KULCSCIM	4.94
00007418830	1051-128 VILLA	4.85
00007418836	1051-128 VILLA	4.85
00007418840	1052-126 KANÁL	4.85
00007418842	1052-126 KANÁL	4.85
00007418845	1052-126 KANÁL	4.85
00007418848	1053-140 KÉS	4.85
00007418851	1053-140 KÉS	4.85
00007418854	1053-140 KÉS	4.85
00007418875	1058-40 CSÉSZE	4.85
00007418878	1058-40 CSÉSZE	4.85
00007418881	1058-40 CSÉSZE	4.85
00007420800	SM 447-32	4.154
00007421200	SM 447-40	4.154
00007421600	SP12-35	4.128
00007421700	SP1-33 PD1	4.128
00007421800	SP1-38 PD1	4.128
00007422223	SP51-39 PF20	4.129
00007422230	SP54-27 PF10	4.129
00007422231	SP54-27 PF11	4.129
00007422240	SP55-35 PF12	4.129
00007422260	SP58-38 PF15	4.129
00007422270	SP59-29 PF16	4.129
00007422710	SM 095-42	4.147
00007423400	SM 391-34	4.155
00007423420	SM 391-34	4.155
00007424300	SM 391-34	4.155
00007424400	SM 391-34 GUMIHATÁSÚ	4.155
00007424900	SM 39-100	4.155
00007425800	SM 592-86	4.155
00007425900	SM 592-124	4.155
00007426000	SM 592-124	4.155
00007426710	SM 592-124	4.155
00007427100	SM 592-124 GUMIHATÁSÚ	4.155
00007427400	SM 592-124	4.155
00007429200	SM 570-128 GUMIHATÁSÚ	4.152
00007432090	8015-25	4.149
00007432091	8015-25	4.149
00007432110	8006-25	4.148

Cikkszám	Típus	Oldal
00007432111	8006-25	4.148
00007432130	8076-15	4.148
00007432131	8076-15	4.148
00007432140	8059-176	4.149
00007432141	8059-176	4.144
00007432150	8059-240	4.149
00007432160	8014-184	4.149
00007432161	8014-184	4.149
00007432162	8014-184	4.144
00007432170	8066-36	4.148
00007432171	8066-36	4.148
00007432180	8045-36	4.149
00007432181	8045-36	4.149
00007432210	8011-110	4.148
00007432211	8011-110	4.148
00007432251	8013-148	4.150
00007432261	8004-164	4.148
00007432320	8116-50	4.139
00007432321	8116-50	4.139
00007432322	8116-50	4.139
00007432323	8116-50	4.139
00007432330	8117-34	4.139
00007432331	8117-34	4.139
00007432332	8117-34	4.139
00007432333	8117-34	4.139
00007432340	8118-30	4.139
00007432341	8118-30	4.139
00007432342	8118-30	4.139
00007432343	8118-30	4.139
00007432344	8118-30	4.139
00007432350	8119-126	4.141
00007432351	8119-126	4.141
00007432352	8119-126	4.141
00007432353	8119-126	4.141
00007432354	8119-126	4.141
00007432360	8086-44	4.146
00007432370	8086-172	4.146
00007432380	8105-144	4.147
00007432390	8104-40	4.145
00007432400	8103-136	4.145
00007432500	8004-164 VONAT	4.135
00007432501	8004-164 TÜNDÉR	4.135
00007432502	8004-164 AUTÓ	4.135
00007432520	8045-36 VONAT	4.135
00007432521	8045-36 TÜNDÉR	4.135
00007432522	8045-36 AUTÓ	4.135
00007432523	8045-36 KACSA	4.135
00007432524	8045-36 KUTYA	4.135
00007432525	8045-36 BÁRÁNY	4.135
00007432526	8045-36 CICA	4.135
00007432531	8045-36 EGÉR	4.135

Cikkszám	Típus	Oldal
00007432600	8077-56	4.144
00007432610	8109-180	4.145
00007432660	8131-78	4.142
00007432670	8132-40	4.145
00007432680	8133-136	4.145
00007432690	8135-202	4.147
00007432700	8137-137	4.147
00007432701	8137-137	4.147
00007432702	8137-137	4.147
00007432703	8137-137	4.147
00007432750	8147-138	4.146
00007432751	8147-202	4.146
00007432760	8151-60	4.144
00007432761	8151-60	4.144
00007432762	8151-60	4.144
00007432763	8151-60	4.144
00007432764	8151-60	4.144
00007432800	8163-47	4.142
00007432801	8163-47	4.142
00007432802	8163-47	4.142
00007432860	8111-80	4.142
00007432861	8111-80	4.142
00007432870	8095-148	4.142
00007432890	0089-144	4.140
00007432891	0089-144	4.140
00007432892	0089-144	4.140
00007432893	0089-144	4.140
00007432894	0089-144	4.140
00007432895	0089-144	4.140
00007432896	0089-144	4.140
00007432897	0089-144	4.140
00007432930	8178-137	4.140
00007432931	8178-137	4.140
00007432932	8178-137	4.140
00007432933	8178-137	4.140
00007432934	8178-137	4.140
00007432935	8178-137	4.140
00007432936	8178-137	4.140
00007432937	8178-137	4.140
00007432940	8200-82	4.140
00007432941	8200-82	4.140
00007432942	8200-82	4.140
00007432943	8200-82	4.140
00007432944	8200-82	4.140
00007432945	8200-82	4.140
00007432946	8200-82	4.140
00007432947	8200-82	4.140
00007432950	8142-182	4.141
00007432951	8142-182	4.141
00007432952	8142-182	4.141
00007432960	8151-60	4.141
00007432961	8151-60	4.141

Cikkszám	Típus	Oldal
00007432962	8151-60	4.141
00007433000	8193-200	4.151
00007433001	8193-200	4.151
00007433002	8193-200	4.151
00007433003	8193-200	4.151
00007433010	8193-246	4.151
00007433011	8193-246	4.151
00007433012	8193-246	4.151
00007433013	8193-246	4.151
00007433020	8193-320	4.151
00007433021	8193-320	4.151
00007433022	8193-320	4.151
00007433023	8193-320	4.151
00007433030	8193-420	4.151
00007433031	8193-420	4.151
00007433032	8193-420	4.151
00007433033	8193-420	4.151
00007433040	8193-510	4.151
00007433041	8193-510	4.151
00007433042	8193-510	4.151
00007433043	8193-510	4.151
00007433100	8214-200	4.151
00007433101	8214-200	4.151
00007433102	8214-200	4.151
00007433103	8214-200	4.151
00007433110	8214-246	4.151
00007433111	8214-246	4.151
00007433112	8214-246	4.151
00007433113	8214-246	4.151
00007433120	8214-320	4.151
00007433121	8214-320	4.151
00007433122	8214-320	4.151
00007433123	8214-320	4.151
00007433130	8214-420	4.151
00007433131	8214-420	4.151
00007433132	8214-420	4.151
00007433133	8214-420	4.151
00007433140	8214-510	4.151
00007433141	8214-510	4.151
00007433142	8214-510	4.151
00007433143	8214-510	4.151
00007433200	8217-200	4.151
00007433201	8217-200	4.151
00007433202	8217-200	4.151
00007433203	8217-200	4.151
00007433210	8217-246	4.151
00007433211	8217-246	4.151
00007433212	8217-246	4.151
00007433213	8217-246	4.151
00007433220	8217-320	4.151
00007433221	8217-320	4.151
00007433222	8217-320	4.151

Cikkszám	Típus	Oldal
00007433223	8217-320	4.151
00007433230	8217-420	4.151
00007433231	8217-420	4.151
00007433232	8217-420	4.151
00007433233	8217-420	4.151
00007433240	8217-510	4.151
00007433241	8217-510	4.151
00007433242	8217-510	4.151
00007433243	8217-510	4.151
00007500000	C265/31	4.34
00007500002	C265/33	4.34
00007500005	C265/11	4.34
00007500030	C293/31	4.31
00007500032	C293/33	4.31
00007500035	C293/11	4.31
00007500080	C303A/31	4.33
00007500082	C303A/33	4.33
00007500085	C303A/11	4.33
00007500087	C303A/69	4.33
00007500090	C303B/31	4.33
00007500092	C303B/33	4.33
00007500095	C303B/11	4.33
00007500097	C303B/69	4.33
00007500100	C303C/31	4.33
00007500102	C303C/33	4.33
00007500105	C303C/11	4.33
00007500107	C303C/69	4.33
00007500110	C305/31	4.34
00007500112	C305/33	4.34
00007500115	C305/11	4.34
00007500120	C306/31	4.34
00007500130	C307/31	4.33
00007500132	C307/33	4.33
00007500137	C307/69	4.33
00007500150	C310/31	4.31
00007500152	C310/33	4.31
00007500155	C310/11	4.31
00007500160	C315A/31	4.32
00007500162	C315A/33	4.32
00007500165	C315A/11	4.32
00007500170	C315B/31	4.32
00007500172	C315B/33	4.32
00007500175	C315B/11	4.32
00007500180	C315C/31	4.32
00007500182	C315C/33	4.32
00007500185	C315C/11	4.32
00007500190	C316/31	4.32
00007500192	C316/33	4.32
00007500195	C316/11	4.32
00007500200	C317/31	4.32
00007500202	C317/33	4.32
00007500205	C317/11	4.32



## 4.204 • Bútorfogantyúk és fogasok • Cikkszám táblázat

Cikkszám	Típus	Oldal	Cikkszám	Típus	Oldal	Cikkszám	Típus	Oldal	Cikkszám	Típus	Oldal
00007500210	C335/31	4.34	00007500485	C338B/31	4.24	00007500770	C382C/31	4.23	00007550150	154-160	4.44
00007500212	C335/33	4.34	00007500520	C360A/11	4.26	00007500772	C382C/33	4.23	00007550151	154-160	4.44
00007500215	C335/11	4.34	00007500525	C360A/31	4.26	00007500777	C382C/69	4.23	00007550180	169-160	4.43
00007500220	C1017/23/0	4.125	00007500530	C360B/11	4.26	00007500780	C387A/31	4.23	00007550181	169-160	4.43
00007500221	C1017/21/B	4.125	00007500535	C360B/31	4.26	00007500782	C387A/33	4.23	00007550190	169-128	4.43
00007500222	C1017/09/B	4.125	00007500540	C360C/11	4.26	00007500787	C387A/69	4.23	00007550191	169-128	4.43
00007500230	C2027/23/0	4.125	00007500545	C360C/31	4.26	00007500790	C387B/31	4.23	00007550200	180-128	4.43
00007500240	C2028/23/0	4.125	00007500550	C363B/31	4.25	00007500792	C387B/33	4.23	00007550201	180-128	4.43
00007500241	C2028/21/B	4.125	00007500555	C363C/31	4.25	00007500797	C387B/69	4.23	00007550220	183-128	4.45
00007500245	C2028/11	4.125	00007500560	C366B/11	4.24	00007500800	C387C/31	4.23	00007550221	183-128	4.45
00007500250	C347A/31	4.30	00007500565	C366B/31	4.24	00007500802	C387C/33	4.23	00007550246	M01.10.00.D1G	4.122
00007500255	C347A/11	4.30	00007500570	C366C/11	4.24	00007500807	C387C/69	4.23	00007550247	M01.01.B1.D1G	4.122
00007500257	C347A/69	4.30	00007500575	C366C/31	4.24	00007500810	C388B/31	4.25	00007550250	M01.01.02.04	4.122
00007500260	C347B/31	4.30	00007500580	C368A/11	4.26	00007500812	C388B/33	4.25	00007550251	M01.01.12.04	4.122
00007500265	C347B/11	4.30	00007500585	C368A/31	4.26	00007500817	C388B/69	4.25	00007550252	M01.01.00.15	4.122
00007500267	C347B/69	4.30	00007500590	C368B/11	4.26	00007500820	C388C/31	4.25	00007550253	M01.01.20.04	4.122
00007500270	C330/31	4.30	00007500595	C368B/31	4.26	00007500822	C388C/33	4.25	00007550254	M01.01.25.04	4.122
00007500275	C330/11	4.30	00007500600	C368C/11	4.27	00007500827	C388C/69	4.25	00007550256	M01.01.01.04	4.122
00007500280	C2033/31	4.27	00007500605	C368C/31	4.27	00007550000	102-128	4.44	00007550257	M01.01.81.04	4.122
00007500285	C2033/11	4.27	00007500610	C368D/11	4.27	00007550001	102-128	4.44	00007550258	M01.01.90.B1G	4.122
00007500300	C336/31	4.29	00007500615	C368D/31	4.27	00007550010	106-160	4.45	00007550259	M01.01.02.B1G	4.122
00007500305	C336/11	4.29	00007500620	C374C/11	4.25	00007550011	106-160	4.45	00007550260	P01.01.02.04	4.121
00007500310	C332A/31	4.31	00007500625	C374C/31	4.25	00007550020	110-32	4.120	00007550264	P01.01.01.04	4.121
00007500315	C332A/11	4.31	00007500650	C374B/11	4.22	00007550021	110-32	4.120	00007550265	P01.01.81.04	4.121
00007500320	C332B/31	4.31	00007500655	C374B/31	4.22	00007550030	120-128	4.123	00007550270	P03.01.02.04	4.121
00007500325	C332B/11	4.31	00007500660	C381A/11	4.21	00007550031	120-128	4.123	00007550271	P03.01.20.04	4.121
00007500330	C348A/31	4.28	00007500665	C381A/33	4.21	00007550040	126-128	4.43	00007550272	P03.01.25.04	4.121
00007500340	C348B/31	4.28	00007500670	C381B/11	4.22	00007550041	126-128	4.43	00007550274	P03.01.01.04	4.121
00007500345	C348B/11	4.28	00007500675	C381B/31	4.22	00007550050	132-160	4.47	00007550275	P03.01.81.04	4.121
00007500350	C352A/31	4.29	00007500680	C381C/11	4.22	00007550051	132-160	4.47	00007550278	P07.01.90.B1G	4.120
00007500355	C352A/11	4.29	00007500685	C381C/31	4.22	00007550052	132-160	4.47	00007550279	P07.01.02.B1G	4.120
00007500360	C352B/31	4.29	00007500690	C383A/11	4.21	00007550053	132-160	4.47	00007550280	P07.01.02.04	4.120
00007500365	C352B/11	4.29	00007500695	C383A/31	4.21	00007550060	132-128	4.47	00007550281	P07.01.20.04	4.120
00007500370	C344/31	4.30	00007500700	C383C/11	4.21	00007550061	132-128	4.47	00007550282	P07.01.25.04	4.120
00007500375	C344/11	4.30	00007500705	C383C/31	4.21	00007550062	132-128	4.47	00007550283	P07.01.12.04	4.120
00007500380	C341/31	4.27	00007500710	C369B/09	4.86	00007550063	132-128	4.47	00007550284	P07.01.01.04	4.120
00007500385	C341/11	4.27	00007500711	C369B/23	4.86	00007550070	132-96	4.47	00007550285	P07.01.81.04	4.120
00007500400	C2040/23	4.84	00007500712	C369B/51	4.86	00007550071	132-96	4.47	00007550286	P07.10.00.D1G	4.120
00007500405	C2040/09	4.84	00007500713	C369B/54	4.86	00007550072	132-96	4.47	00007550287	P07.01.B1.D1G	4.120
00007500410	C1020B/23	4.84	00007500720	C369C/09	4.86	00007550073	132-96	4.47	00007550288	P07.01.A1.D1G	4.120
00007500412	C1020C/23	4.84	00007500721	C369C/23	4.86	00007550080	132-64	4.47	00007550289	P07.21.22.D1G	4.120
00007500415	C1020B/09	4.84	00007500722	C369C/51	4.86	00007550081	132-64	4.47	00007550290	P08.01.02.04	4.121
00007500417	C1020C/9	4.84	00007500723	C369C/54	4.86	00007550082	132-64	4.47	00007550291	P08.01.20.04	4.121
00007500440	C2041C/23	4.86	00007500730	C380/11	4.21	00007550083	132-64	4.47	00007550292	P08.01.25.04	4.121
00007500445	C2041C/09	4.86	00007500735	C380/31	4.21	00007550100	138-192	4.43	00007550293	P08.01.12.04	4.121
00007500450	C2041C/51	4.86	00007500740	C384A/11	4.21	00007550101	138-192	4.43	00007550294	P08.01.01.04	4.121
00007500455	C2041C/54	4.86	00007500745	C384A/31	4.21	00007550120	145-160	4.45	00007550295	P08.01.81.04	4.121
00007500460	C323/11	4.22	00007500750	C384B/11	4.21	00007550121	145-160	4.45	00007550308	M10.01.90.B1G	4.118
00007500465	C323/31	4.22	00007500755	C384B/31	4.21	00007550130	153-160	4.45	00007550309	M10.01.02.B1G	4.118
00007500470	C338A/11	4.24	00007500760	C382A/31	4.23	00007550131	153-160	4.45	00007550310	M10.01.20.04	4.118
00007500475	C338A/31	4.24	00007500762	C382A/33	4.23	00007550140	153-128	4.45	00007550311	M10.01.25.04	4.118
00007500480	C338B/11	4.24	00007500767	C382A/69	4.23	00007550141	153-128	4.45	00007550312	M10.01.12.04	4.118

Cikkszám	Típus	Oldal	Cikkszám	Típus	Oldal	Cikkszám	Típus	Oldal	Cikkszám	Típus	Oldal
00007550313	M10.01.01.04	4.118	00007550631	503-000	4.105	00007551100	532-128	4.107	00007551651	634-031	4.114
00007550314	M10.01.02.04	4.118	00007550640	225-96	4.103	00007551101	532-128	4.107	00007551660	636-128	4.114
00007550315	M10.01.81.04	4.118	00007550650	225-16	4.103	00007551110	532-96	4.107	00007551662	636-45	4.114
00007550316	M10.10.00.D1G	4.118	00007550680	214-96	4.102	00007551111	532-96	4.107	00007551670	637-160	4.114
00007550317	M10.01.B1.D1G	4.118	00007550690	114-000	4.104	00007551120	534-96	4.107	00007551680	638-128	4.112
00007550318	M10.01.A1.D1G	4.118	00007550700	226-96	4.103	00007551121	534-96	4.107	00007551681	638-32	4.112
00007550319	M10.21.22.D1G	4.118	00007550710	226-24	4.104	00007551130	534-128	4.107	00007551700	2028-25	4.111
00007550330	M17.01.02.04	4.119	00007550720	224-96	4.102	00007551131	534-128	4.107	00007551701	2028-30	4.111
00007550331	M17.01.81.04	4.119	00007550721	224-96	4.102	00007551170	005-B32	4.44	00007551702	2028-35	4.111
00007550332	M17.01.90.B1G	4.119	00007550730	224-16	4.103	00007551171	005-B32	4.44	00007551710	541.064.00F7	4.46
00007550333	M17.01.02.B1G	4.119	00007550731	224-16	4.103	00007551180	300.032.0001	4.44	00007551720	543.064.00F7	4.46
00007550335	M17.01.B1.D1G	4.119	00007550740	228-96	4.104	00007551181	300.032.0002	4.44	00007551730	317.064.0003	4.46
00007550340	M50.01.02.04	4.119	00007550750	231-96	4.103	00007551182	300.032.0003	4.44	00007551731	317.064.0002	4.46
00007550341	M50.01.81.04	4.119	00007550751	231-96	4.103	00007551230	552.096.00D1	4.99	00007551740	317.032.0003	4.46
00007550343	M50.01.02.B1G	4.119	00007550755	231-128	4.103	00007551231	552.128.00D1	4.99	00007551741	317.032.0002	4.46
00007550344	M50.10.00.D1G	4.119	00007550760	218-96	4.104	00007551250	602.030.00D1	4.96	00007551770	648.128.00F7	4.110
00007550345	M50.01.B1.D1G	4.119	00007550770	118-000	4.104	00007551261	603.096.00D1	4.99	00007551771	648.128.00A8	4.110
00007550350	M51.01.02.04	4.118	00007550780	229-96	4.106	00007551262	603.128.00D1	4.99	00007551780	648.032.00F7	4.110
00007550351	M51.01.81.04	4.118	00007550790	229-30	4.106	00007551281	604.096.00D1	4.98	00007551781	648.032.00A8	4.110
00007550352	M51.01.90.B1G	4.118	00007550800	222-96	4.101	00007551282	604.128.00D1	4.98	00007551811	634.031.00M1	4.114
00007550354	M51.10.00.D1G	4.118	00007550810	222-32	4.101	00007551380	610.096.00D1	4.97	00007551820	670.096.00D1	4.112
00007550355	M51.01.B1.D1G	4.118	00007550820	501-96	4.105	00007551400	611.032.00D1	4.98	00007551821	670.096.00M1	4.112
00007550360	P04.01.20.04	4.121	00007550821	501-96	4.105	00007551401	611.096.00D1	4.98	00007551830	670.128.00D1	4.112
00007550361	P04.01.25.04	4.121	00007550830	501-000	4.105	00007551402	611.128.00D1	4.98	00007551831	670.128.00M1	4.112
00007550364	P04.01.02.04	4.121	00007550831	501-000	4.105	00007551410	614.D64.0002	4.96	00007551840	659.032.00D1	4.111
00007550365	P04.01.81.04	4.121	00007550840	215-96	4.104	00007551411	614.D96.0002	4.96	00007551850	659.064.00D1	4.111
00007550372	P10.01.00.06	4.128	00007550850	115-000	4.104	00007551415	614.S64.0002	4.96	00007551860	659.128.00D1	4.111
00007550373	P10.00.00.06	4.128	00007550851	115-000	4.104	00007551416	614.S96.0002	4.96	00007551870	675.096.00D1	4.111
00007550435	P23.10.00.04	4.122	00007550860	232-96	4.101	00007551420	614.D64.00D1	4.96	00007551880	675.192.00D1	4.111
00007550436	P23.01.00.04	4.122	00007550870	232-32	4.101	00007551421	614.D96.00D1	4.96	00007551890	695.000.00D1	4.109
00007550440	P18.01.02.B1G	4.122	00007550880	516-96	4.101	00007551425	614.S64.00D1	4.96	00007551900	695.096.00D1	4.109
00007550472	M12.01.81.D1G	4.122	00007550890	514-96	4.101	00007551426	614.S96.00D1	4.96	00007551910	695.128.00D1	4.109
00007550480	M19.01.81.D1G	4.123	00007550900	514-000	4.101	00007551450	2023/30.D1	4.97	00007551920	685.000.00M1	4.112
00007550481	M19.01.B1.D1G	4.123	00007550910	515-96	4.102	00007551460	6017/0A.D1	4.97	00007551921	685.000.00D1	4.112
00007550482	M19.01.02.D1G	4.123	00007550920	515-000	4.102	00007551470	6022/30.D1	4.97	00007551930	685.096.00M1	4.112
00007550490	M22.01.B1.D1G	4.123	00007550930	7115/42	4.102	00007551480	6200/32.D1	4.97	00007551931	685.096.00D1	4.112
00007550500	2025-25	4.99	00007550940	518-000	4.102	00007551481	6200/32.0002	4.97	00007551940	688.000.0002	4.110
00007550501	2025-25	4.99	00007550950	221-96	4.106	00007551540	M55.01.00.D1G	4.123	00007551941	688.000.00F7	4.110
00007550510	2025-35	4.99	00007550960	221-64	4.106	00007551590	622.032.00D1	4.109	00007551950	688.096.0002	4.110
00007550511	2025-35	4.99	00007550970	216-96	4.105	00007551600	622.ADX.00D1 JOBOS	4.109	00007551951	688.096.00F7	4.110
00007550520	5021/A	4.100	00007550980	533-96	4.107	00007551610	622.ASX.00D1 BALOS	4.109	00007551960	688.128.0002	4.110
00007550530	5059	4.100	00007550990	533-128	4.107	00007551620	622.BDX.00D1 JOBOS	4.109	00007551961	688.128.00F7	4.110
00007550540	5042/A	4.100	00007551000	133-96	4.106	00007551630	622.BSX.00D1 BALOS	4.109	00007551970	688.224.0002	4.110
00007550550	5042/B	4.100	00007551010	133-128	4.106	00007551640	628-224	4.113	00007551971	688.224.00F7	4.110
00007550560	5091	4.101	00007551020	540-75	4.108	00007551641	628-224	4.113	00007552000	550.096.KR04	4.71
00007550580	5031/B	4.100	00007551030	542-75	4.108	00007551642	628-128	4.113	00007552001	550.096.SAE2	4.71
00007550590	5031/A	4.100	00007551040	536-128	4.108	00007551643	628-96	4.113	00007552002	550.096.KRE2	4.71
00007550600	504-96	4.106	00007551050	536-96	4.108	00007551644	628-96	4.113	00007552003	550.096.EMGP	4.71
00007550610	504-32	4.106	00007551060	537-64	4.108	00007551645	628-000	4.113	00007552010	550.016.KR04	4.71
00007550620	503-96	4.105	00007551070	536-000	4.108	00007551645	628-000	4.113	00007552011	550.016.SAE2	4.71
00007550621	503-96	4.105	00007551080	545-000	4.108	00007551645	628-000	4.113	00007552012	550.016.KRE2	4.71
00007550630	503-000	4.105	00007551090	546-000	4.108				00007552013	550.016.EMGP	4.71

## 4.206 • Bútorfogantyúk és fogasok • Cikkszám táblázat

Cikkszám	Típus	Oldal
00007552021	550.032.SAE2	4.71
00007552022	550.032.KRE2	4.71
00007552023	550.032.EMGP	4.71
00007552030	550.128.KR02	4.71
00007552040	552.025.KR02	4.71
00007552050	550.000.KR02	4.71
00007552100	550.096.RSG02	4.78
00007552101	550.096.RBG02	4.78
00007552111	550.016.RBG02	4.78
00007552112	550.016.RIV02	4.78
00007552120	550.032.RSG02	4.78
00007552121	550.032.RBG02	4.78
00007552130	633.017.KRE2	4.73
00007552131	633.017.KR03	4.73
00007552132	633.017.KR02	4.73
00007552140	633.096.KR02	4.72
00007552141	633.096.KRE2	4.72
00007552142	633.096.KR03	4.72
00007552150	633.C32.KRE2	4.72
00007552151	633.C32.KR03	4.72
00007552152	633.C32.KR02	4.72
00007552160	633.128.KR02	4.72
00007552161	633.128.KRE2	4.72
00007552162	633.128.KR03	4.72
00007552170	633.A64.KR02	4.72
00007552180	633.B32.KR02	4.72
00007552181	633.B32.KR03	4.72
00007552182	633.B32.KRE2	4.72
00007552190	640.096.KR03	4.73
00007552191	640.096.KRL8	4.73
00007552200	640.032.KR03	4.73
00007552201	640.032.KRL8	4.73
00007552210	640.016.KRL8	4.73
00007552211	640.016.KR03	4.73
00007552220	655.016.KR02	4.77
00007552221	655.016.KR03	4.77
00007552222	655.016.KRD1	4.77
00007552230	655.000.KR02	4.77
00007552231	655.000.KR03	4.77
00007552232	655.000.KRD1	4.77
00007552240	694.000.KRP9	4.76
00007552241	694.000.KRL8	4.76
00007552250	694.096.KRP9	4.76
00007552251	694.096.KRL8	4.76
00007552260	694.128.KRP9	4.76
00007552261	694.128.KRL8	4.76
00007552270	694.160.KRP9	4.76
00007552271	694.160.KRL8	4.76
00007552280	693.015.KR03	4.74
00007552281	693.015.KRE2	4.74
00007552290	693.031.KR03	4.74
00007552291	693.031.KRE2	4.74

Cikkszám	Típus	Oldal
00007552300	693.032.KR03	4.74
00007552301	693.032.KRE2	4.74
00007552320	693.128.KR03	4.74
00007552321	693.128.KRE2	4.74
00007552330	667.016.KR03	4.75
00007552331	667.016.KRE2	4.75
00007552340	667.032.KR03	4.75
00007552341	667.032.KRE2	4.75
00007552350	667.096.KR03	4.75
00007552351	667.096.KRE2	4.75
00007552360	667.128.KR03	4.75
00007552361	667.128.KRE2	4.75
00007552370	580.224.00M2	4.6
00007552371	580.224.00R3	4.6
00007552372	580.224.0002	4.6
00007552380	0006.192.0003	4.6
00007552381	0006.192.0002	4.6
00007552382	0006.192.0001	4.6
00007552410	187.224.0003	4.6
00007552411	187.224.0001	4.6
00007552400	187.160.0003	4.7
00007552401	187.160.0001	4.7
00007552390	187.096.0003	4.7
00007552391	187.096.0001	4.7
00007552460	706.035.00D1	4.7
00007552461	706.035.00T5	4.7
00007552462	706.035.00R3	4.7
00007552450	712.000.00D1	4.8
00007552451	712.000.00T5	4.8
00007552420	719.000.00D1	4.8
00007552421	719.000.00T5	4.8
00007552430	719.128.00D1	4.8
00007552431	719.128.00T5	4.8
00007552440	711.064.00D1	4.9
00007552441	711.064.00T5	4.9
00007552470	M70.01.G2.T5G	4.9
00007552471	P88.01.G2.T5G	4.9
00007552480	M70.01.G6.B1G	4.9
00007552481	P88.01.G6.B1G	4.9
00007552490	M70.01.G2.D1G	4.9
00007552491	P88.01.G2.D1G	4.9
00007590000	MB0909700	4.143
00007590001	MB0909700	4.143
00007590002	MB0909700	4.143
00007590010	MB0909700	4.143
00007590020	MB0913000	4.143
00007590021	MB0913000	4.143
00007590030	MB0909900	4.35
00007590040	MB09078B0	4.37
00007590050	MB09107B0	4.35
00007590060	MB09129B0	4.35
00007590061	MB09129B0	4.35

Cikkszám	Típus	Oldal
00007590070	MB09045A0	4.37
00007590080	MB09132B0	4.37
00007590081	MB09132B0	4.37
00007590090	MB09098B0	4.35
00007590110	MB091020M	4.36
00007590111	MB091020M	4.36
00007590120	MB09142B0	4.36
00007590121	MB09142B0	4.36
00007590122	MB09142B0	4.36
00007590130	MB0914300	4.36
00007590131	MB0914300	4.36
00007590132	MB0914300	4.36
00007590140	MB0914400	4.36
00007590141	MB0914400	4.36
00007590142	MB0914400	4.36
00007590150	MB09148A0	4.36
00007590151	MB09148A0	4.36
00007601321	T 241-96	4.58
00007601322	T 241-96	4.58
00007601333	T 243-96	4.56
00007601334	T 243-96	4.56
00007601335	T 243-96	4.56
00007601339	T 244-64	4.57
00007601340	T 244-64	4.57
00007601343	T 244-96	4.57
00007601344	T 244-96	4.57
00007601345	T 244-96	4.57
00007601346	T 244-96	4.57
00007601375	T 250-96	4.54
00007601376	T 250-96	4.54
00007601379	T 250-128	4.54
00007601380	T 250-128	4.54
00007601389	T 252-28	4.54
00007601390	T 252-28	4.54
00007601393	T 252-28	4.54
00007601396	T 253-96	4.54
00007601397	T 253-96	4.54
00007601398	T 253-96	4.54
00007602300	T 204-96	4.55
00007602400	T 204-96	4.55
00007602500	T 204-96	4.55
00007605800	T 223-96	4.58
00007605900	T 223-96	4.58
00007606000	T 223-96	4.58
00007606422	T 229-76	4.88
00007606428	T 231-92	4.88
00007606429	T 232-96	4.55
00007606430	T 232-96	4.55
00007606431	T 232-96	4.55
00007606432	T 232-128	4.55
00007606433	T 232-128	4.55
00007606435	T 233-96	4.58

Cikkszám	Típus	Oldal
00007606436	T 233-96	4.58
00007606437	T 233-96	4.58
00007606438	T 234-128	4.58
00007606440	T 234-128	4.58
00007606470	T 236-128	4.56
00007606472	T 236-128	4.56
00007606484	T 238-96	4.56
00007606485	T 238-96	4.56
00007607900	T 306-26	4.70
00007608800	T 402-38	4.128
00007609000	T 404-35	4.128
00007610000	T254-96	4.58
00007610001	T254-96	4.58
00007610003	T254-96	4.58
00007610004	T254-96	4.58
00007610005	T254-96	4.58
00007610006	T254-96	4.58
00007610010	T255-128	4.54
00007610011	T255-128	4.54
00007610012	T255-128	4.54
00007610021	T256-96	4.57
00007610030	T257-96	4.55
00007610031	T257-96	4.55
00007610040	T258-96	4.57
00007610041	T258-96	4.57
00007610042	T258-96	4.57
00007610051	T259-64	4.57
00007610052	T259-64	4.57
00007611000	T-500	4.137
00007611001	T-500	4.137
00007611002	T-500	4.137
00007611010	T-501	4.137
00007611020	T-502	4.137
00007611040	T-505	4.136
00007611050	T-506	4.137
00007611060	T-507	4.136
00007611070	T-508	4.136
00007611090	T-510	4.136
00007611100	T-511	4.137
00007611110	T-511	4.137
00007611130	T-513	4.136
00007611140	T-514	4.136
00007650000	A001-096/146	4.15
00007650010	A001-128/178	4.15
00007650020	A001-160/210	4.15
00007650030	A001-192/242	4.15
00007650040	A001-224/274	4.15
00007650043	A001-256/306	4.15
00007650046	A001-288/338	4.15
00007650050	A001-320/370	4.15
00007650053	A001-352/402	4.15
00007650056	A001-384/434	4.15

Cikkszám	Típus	Oldal
00007650060	A001-480/530	4.15
00007650063	A001-576/626	4.15
00007650110	A003-096	4.16
00007650120	A003-128	4.16
00007650150	A005-096	4.16
00007650160	A005-128	4.16
00007650170	A006-064	4.16
00007650180	A006-096	4.16
00007650190	A006-128	4.16
00007650230	A008-064/084	4.16
00007650240	A008-096/116	4.16
00007650250	A008-128/148	4.16
00007650260	A009-128	4.17
00007650270	A009-160	4.17
00007650290	A010-128	4.17
00007650320	A013-128	4.17
00007650370	E002-064	4.60
00007650371	E002-064	4.60
00007650372	E002-064	4.60
00007650373	E002-064	4.60
00007650380	E002-096	4.61
00007650381	E002-096	4.61
00007650382	E002-096	4.61
00007650383	E002-096	4.61
00007650384	E002-096	4.61
00007650390	E002-128	4.61
00007650391	E002-128	4.61
00007650392	E002-128	4.61
00007650393	E002-128	4.61
00007650400	E003-096	4.60
00007650401	E003-096	4.60
00007650402	E003-096	4.60
00007650403	E003-096	4.60
00007650410	E004-096	4.61
00007650411	E004-096	4.61
00007650413	E004-096	4.61
00007650414	E004-096	4.61
00007650415	E004-096	4.61
00007650420	E005-096	4.61
00007650421	E005-096	4.61
00007650423	E005-096	4.61
00007650430	E005-128	4.61
00007650431	E005-128	4.61
00007650433	E005-128	4.61
00007650450	E006-128	4.62
00007650451	E006-128	4.62
00007650452	E006-128	4.62
00007650453	E006-128	4.62
00007650480	E008-096	4.62
00007650481	E008-096	4.62
00007650482	E008-096	4.62
00007650483	E008-096	4.62

Cikkszám	Típus	Oldal
00007650490	E008-128	4.62
00007650491	E008-128	4.62
00007650492	E008-128	4.62
00007650493	E008-128	4.62
00007650540	E011-128	4.62
00007650541	E011-128	4.62
00007650542	E011-128	4.62
00007650543	E011-128	4.62
00007650560	E013-032	4.63
00007650561	E013-032	4.63
00007650563	E013-032	4.63
00007650570	E014-096	4.63
00007650571	E014-096	4.63
00007650572	E014-096	4.63
00007650573	E014-096	4.63
00007650580	E015-064	4.63
00007650581	E015-064	4.63
00007650582	E015-064	4.63
00007650583	E015-064	4.63
00007650590	E015-096	4.64
00007650591	E015-096	4.64
00007650592	E015-096	4.64
00007650593	E015-096	4.64
00007650594	E015-096	4.64
00007650600	E015-128	4.64
00007650601	E015-128	4.64
00007650602	E015-128	4.64
00007650603	E015-128	4.64
00007650620	E017-096	4.64
00007650621	E017-096	4.64
00007650622	E017-096	4.64
00007650623	E017-096	4.64
00007650630	E018-064	4.64
00007650631	E018-064	4.64
00007650632	E018-064	4.64
00007650633	E018-064	4.64
00007650640	E018-096	4.60
00007650641	E018-096	4.60
00007650642	E018-096	4.60
00007650643	E018-096	4.60
00007650652	E018-128	4.60
00007650653	E018-128	4.60
00007650660	E019-096	4.63
00007650661	E019-096	4.63
00007650662	E019-096	4.63
00007650663	E019-096	4.63
00007650670	E019-128	4.63
00007650671	E019-128	4.63
00007650672	E019-128	4.63
00007650673	E019-128	4.63
00007650810	E032-096	4.65
00007650811	E032-096	4.65

Cikkszám	Típus	Oldal
00007650813	E032-096	4.65
00007650814	E032-096	4.65
00007650820	E032-128	4.65
00007650821	E032-128	4.65
00007650823	E032-128	4.65
00007650830	E033-096	4.65
00007650832	E033-096	4.65
00007650876	E037-096/136	4.14
00007650880	E037-128/168	4.14
00007650890	E037-160/200	4.14
00007650892	E037-192/232	4.14
00007650895	E037-224/264	4.14
00007650897	E037-256/296	4.14
00007650900	E037-288/328	4.14
00007650905	E037-320/360	4.14
00007650910	E037-352/392	4.14
00007650915	E037-384/424	4.14
00007650920	E037-448/488	4.14
00007650930	E037-560/600	4.14
00007650940	E037-660/700	4.14
00007650950	E037-760/800	4.14
00007651004	E040-096	4.115
00007651014	E041-096	4.115
00007651024	E042-096	4.116
00007651044	E044-000	4.116
00007651054	E044-096	4.116
00007651064	E044-128	4.116
00007651074	E045-096	4.116
00007651084	E046-096	4.117
00007651094	E046-128	4.117
00007651104	E047-096	4.117
00007651114	E048-096	4.117
00007651124	E048-128	4.117
00007651134	E049-096	4.117
00007652000	E038-96	4.124
00007652001	E038-96	4.124
00007652002	E038-96	4.124
00007652020	E039-26	4.124
00007652021	E039-26	4.124
00007652022	E039-26	4.124
00007652030	E050-96	4.124
00007652031	E050-96	4.124
00007652032	E050-96	4.124
00007652040	E051-96	4.124
00007652041	E051-96	4.124
00007652042	E051-96	4.124
00007652050	E052-96	4.124
00007652051	E052-96	4.124
00007652052	E052-96	4.124
00007652060	E053-33	4.125
00007652061	E053-33	4.125
00007652062	E053-33	4.125

Cikkszám	Típus	Oldal
00007652100	E054-192	4.48
00007652101	E054-192	4.48
00007652102	E054-192	4.48
00007652110	E055-034	4.48
00007652111	E055-034	4.48
00007652112	E055-034	4.48
00007652120	E056-160	4.48
00007652121	E056-160	4.48
00007652130	E057-160	4.48
00007652131	E057-160	4.48
00007652140	E058-042	4.48
00007652141	E058-042	4.48
00007652150	E059-160	4.66
00007652160	E059-256	4.66
00007652170	E060-128	4.66
00007652180	E060-192	4.66
00007652190	E060-256	4.66
00007652200	E061-128	4.66
00007652210	E061-192	4.66
00007652220	E062-128	4.65
00007652230	E062-160	4.65
00007652240	E062-192	4.65
00007652250	E062-256	4.65
00007652260	E063-128	4.66
00007652270	E063-192	4.66
00007653030	A015-096	4.18
00007653040	A015-128	4.18
00007653050	A015-160	4.18
00007653060	A016-096	4.18
00007653070	A016-128	4.18
00007653080	A016-160	4.18
00007653090	A016-192	4.18
00007653130	A018-096	4.18
00007653140	A018-128	4.18
00007653150	A018-160	4.18
00007653160	A018-192	4.18
00007653170	A019-020	4.19
00007653180	A020-022	4.19
00007653190	A020-025	4.19
00007653200	A021-096	4.18
00007653210	A021-128	4.18
00007653220	A021-160	4.18
00007653230	A021-192	4.18
00007653260	A023-096	4.19
00007653270	A023-128	4.19
00007653280	A023-160	4.19
00007653290	A024-096	4.19
00007653300	A024-128	4.19
00007653310	A024-160	4.19
00007653320	A024-192	4.19
00007653330	A025-096	4.17
00007653340	A025-128	4.17

## 4.208 • Bútorfogantyúk és fogasok • Cikkszám táblázat

Cikkszám	Típus	Oldal	Cikkszám	Típus	Oldal	Cikkszám	Típus	Oldal	Cikkszám	Típus	Oldal
00007653350	A025-160	4.17	00007805006	P 201/C-128	4.154	00007902020	F 144-35	4.164	00008004800	S 70-44	4.157
00007653360	A025-192	4.17	00007805609	P 214/C-128	4.152	00007902050	F 147-35	4.164	00008004900	S 70-44	4.157
00007653370	A026-096	4.17	00007807202	P 273-35 TOLÓAJTÓKAGYLÓ	4.156	00007902100	F 150-33	4.163	00008005100	S 87-30	4.159
00007653380	A026-128	4.17	00007807204	P 273-35 TOLÓAJTÓKAGYLÓ	4.156	00007902200	F 160-36	4.164	00008005300	S 87-30	4.159
00007653390	A026-160	4.17	00007807206	P 273-35 TOLÓAJTÓKAGYLÓ	4.156	00007902210	F 163-36	4.164	00008005400	S 87-35	4.159
00007653400	A026-192	4.17	00007807208	P 273-35 TOLÓAJTÓKAGYLÓ	4.156	00007902220	F 164-36	4.164	00008005500	S 87-35	4.159
00007653410	A027-295	4.10	00007807210	P 273-35 TOLÓAJTÓKAGYLÓ	4.156	00007902230	F 165-36	4.164	00008005600	S 87-35	4.159
00007653420	A027-395	4.10	00007807212	P 273-35 TOLÓAJTÓKAGYLÓ	4.156	00007902240	F 166-36	4.164	00008005700	S 87-35	4.159
00007653430	A027-595	4.10	00007807214	P 273-35 TOLÓAJTÓKAGYLÓ	4.156	00007902250	F 167-36	4.164	00008005900	S 87-44	4.159
00007653440	A028-295	4.10	00007807216	P 274-125 TOLÓAJTÓKAGYLÓ	4.156	00007902300	F 500-96	4.163	00008006000	S 87-44	4.159
00007653450	A028-395	4.10	00007807218	P 274-125 TOLÓAJTÓKAGYLÓ	4.156	00007902700	F 510-128	4.163	00008006100	S 87-44	4.159
00007653460	A028-595	4.10	00007807222	P 274-125 TOLÓAJTÓKAGYLÓ	4.156	00007903100	F 520-96	4.166	00008007200	6017-128	4.168
00007700000	EM-054	4.68	00007807224	P 274-125 TOLÓAJTÓKAGYLÓ	4.156	00007903150	F 524-96	4.166	00008007800	6022-96	4.167
00007700001	EM-054	4.68	00007808000	426 X	4.138	00007903200	F 525-96	4.166	00008007900	6022-96	4.167
00007700010	EM-053	4.67	00007808002	426 X	4.138	00007903300	F 526-96	4.166	00008008300	6023-128	4.168
00007700011	EM-053	4.67	00007808003	426 X	4.138	00007904400	F 564-96	4.157	00008008900	8005-96	4.168
00007700020	EM-022	4.68	00007808001	427 P	4.135	00007904930	F597-128	4.165	00008008921	S 251-133	4.160
00007700021	EM-022	4.68	00007808002	427 G	4.135	00007905200	F 605-96	4.163	00008008922	S 251-133	4.160
00007700030	EM-093	4.68	00007808003	399	4.138	00007905200	F 605-96	4.163	00008008931	S 251-170	4.161
00007700031	EM-093	4.68	00007808004	399	4.138	00007905350	F607-96	4.163	00008008932	S 251-170	4.161
00007700040	EM-011-E	4.68	00007808005	57	4.156	00007905415	F 610-96	4.164	00008008932	S 251-170	4.161
00007700041	EM-011-E	4.68	00007808070	96/M	4.138	00007905418	F 613-96	4.164	00008008961	S 499-59	4.162
00007700050	EM-013-D GOMB	4.68	00007808110	37/B	4.143	00007905419	F 614-96	4.164	00008008962	S 499-59	4.162
00007700051	EM-013-D GOMB	4.68	00007808120	37/B	4.143	00007905420	F 615-96	4.164	00008008991	S 514-154	4.160
00007700060	EM-603	4.115	00007808130	306	4.143	00007905421	F 616-96	4.164	00008008992	S 514-154	4.160
00007700070	EM-603	4.115	00007808140	306	4.143	00007905422	F 617-96	4.164	00008009050	S 503-72	4.162
00007700100	BR 170	4.115	00007808141	306	4.143	00007905423	F 618-96	4.164	00008009052	S 503-72	4.162
00007700110	BR 170	4.115	00007900400	F 110-34	4.165	00007905424	F 619-96	4.164	00008009070	S 579-35	4.160
00007700121	BR 189	4.67	00007900450	F 113-34	4.165	00007905430	F 620-64	4.164	00008009072	S 579-35	4.160
00007700122	BR 189	4.67	00007900500	F 114-34	4.165	00007905439	F 627-64	4.164	00008009075	S 579-35	4.160
00007700142	BR 189	4.67	00007900600	F 115-34	4.165	00007905460	F640-96	4.165	00008009083	059-38	4.160
00007700181	BR-512	4.67	00007900700	F 116-34	4.165	00007905467	F647-96	4.165	00008009100	423-30	4.160
00007700182	BR-512	4.67	00007900750	F 117-34	4.165	00008000305	G 17-110	4.158	00008009102	423-30	4.160
00007700183	BR-512	4.67	00007900800	F 118-34	4.165	00008000700	S 113-108	4.158	00008009105	423-30	4.160
00007800100	P 91-27	4.153	00007900810	F 119-34	4.165	00008001100	S 113-76	4.159	00008009260	R-0986-26	4.166
00007800200	P 91-27	4.153	00007901000	F 120-34	4.163	00008002200	S 138-120	4.158	00008009261	R-0986-26	4.166
00007800300	P 91-27	4.153	00007901200	F 125-34	4.163	00008002300	S 138-120	4.158	00008009262	R-0986-26	4.166
00007800500	P 91-27	4.153	00007901500	F 130-45	4.165	00008002310	S 138-120	4.158	00008009282	R-1104-128	4.166
00007801000	P 91/B-32	4.154	00007901550	F 133-45	4.165	00008002700	S 138-88	4.158	00008009290	R-0992-20	4.166
00007801100	P 91/B-32	4.154	00007901600	F 134-45	4.165	00008002800	S 30-112	4.158	00008009301	S529-25	4.167
00007801200	P 91/B-32	4.154	00007901700	F 135-45	4.165	00008002900	S 30-112	4.158	00008009310	R-1102-96	4.161
00007801300	P 91/B-32	4.154	00007901800	F 136-45	4.165	00008003100	S 30-112	4.158	00008009330	2358-108	4.161
00007801303	P 91/B-32	4.154	00007901850	F 137-45	4.165	00008003500	S 30-82	4.158	00008009350	R-1101-160	4.167
00007801306	P 91/B-32	4.154	00007901900	F 138-45	4.165	00008003600	S 300-35	4.159	00008009352	R-1101-160	4.167
00007801500	P 91/B-32	4.152	00007901910	F 139-45	4.165	00008003900	S 70-30	4.157	00008009360	R-1567	4.162
00007802400	P 201/A-64	4.154	00007902000	F 140-35	4.164	00008004000	S 70-30	4.157	00008009370	R-0961A	4.161
00007804300	P 201/B-96	4.153				00008004100	S 70-30	4.157	00008009371	R-0961A	4.161
00007804700	P 201/C-128	4.154				00008004200	S 70-35	4.157	00008009380	S638-14	4.162
00007804800	P 201/C-128	4.154				00008004300	S 70-35	4.157	00008009390	S637A-20	4.162
00007805000	P 201/C-128	4.154				00008004400	S 70-35	4.157	00008009391	S637A-20	4.162
00007805003	P 201/C-128	4.154				00008004405	S 70-35	4.157	00008009392	S637A-20	4.162
						00008004500	S 70-35	4.157	00008100462	G 143-25	4.70
						00008004700	S 70-44	4.157	00008100477	G 144-19	4.70



Cikkszám	Típus	Oldal
00008101000	G 681/B-30	4.88
00008101100	G 681/B-30	4.88
00008101200	G 681/B-30	4.88
00008101244	G 682-30	4.88
00008101246	G 682-30	4.88
00008102100	G 798-30	4.70
00008102200	G 798-30	4.70
00008103600	G 1008-64	4.59
00008103800	G 1008-96	4.59
00008104000	G 1008-128	4.59
00008104400	G 972-96	4.59
00008104405	G 972-96	4.59
00008104900	G 980-96	4.59
00008105000	G 980-96	4.59
00008105100	G 980-96	4.59
00008105200	G 980-96	4.59
00008105300	G 980-96	4.59
00008105500	G 980-128	4.59
00008105600	G 980-128	4.59
00008105700	G 985-128	4.55
00008105800	G 985-128	4.55
00008105900	G 985-128	4.55
00008106000	G 955-96	4.56
00008106020	G 955-96	4.56
00008106120	G 982-128	4.59
00008800200	0487	4.188
00008800700	0488	4.188
00008801420	0616	4.188
00008801440	0617	4.188
00008801460	430	4.182
00008801465	430	4.182
00008801470	431	4.182
00008801475	431	4.182
00008801500	504 *	4.182
00008801700	504 *	4.182
00008801800	505 *	4.182
00008801900	505 *	4.182
00008802000	505 *	4.182
00008802100	547 *	4.180
00008802400	548	4.180
00008802800	553 *	4.180
00008803100	554 *	4.180
00008803200	557 *	4.181
00008803400	558 *	4.181
00008803600	817	4.179
00008803700	817	4.179
00008805000	1096	4.179
00008805100	1096	4.179
00008805200	1096	4.179
00008805300	1096	4.179
00008805400	1096	4.179
00008805500	1096	4.179

Cikkszám	Típus	Oldal
00008805600	1097	4.178
00008805700	1097	4.178
00008805800	1097	4.178
00008805900	1097	4.178
00008806000	1097	4.178
00008806100	1097	4.178
00008820040	851	4.177
00008820041	851	4.177
00008820111	1098	4.177
00008820160	1229	4.181
00008820170	1230	4.181
00008820200	1236	4.179
00008820201	1236	4.179
00008820210	1237	4.179
00008820211	1237	4.179
00008820213	1237	4.179
00008820240	1278	4.176
00008820241	1278	4.176
00008820243	1278	4.176
00008820250	1279	4.176
00008820251	1279	4.176
00008820253	1279	4.176
00008820260	1280	4.177
00008820261	1280	4.177
00008820262	1280	4.177
00008820263	1280	4.177
00008820270	1281	4.177
00008820271	1281	4.177
00008820272	1281	4.177
00008820273	1281	4.177
00008820280	1282	4.176
00008820281	1282	4.176
00008820283	1282	4.176
00008820311	1420	4.181
00008820312	1420	4.181
00008820321	1421	4.181
00008820322	1421	4.181
00008820400	1653	4.178
00008820410	1654	4.178
00008820420	1672 ZN21	4.177
00008820460	1821 ZNS5	4.183
00008820470	1981 ZN1A4	4.183
00008820480	1981 ZN31A78	4.183
00008820490	1982 ZN1A4	4.183
00008820500	1982 ZN31A78	4.183
00008820510	2050 SN-15PB21A105	4.189
00008820520	2051 SN-16PB21A105	4.189
00008820530	2052 SN-10PB21A105	4.189
00008820540	2019 ZN29	4.183
00008820550	2019 ZN31	4.183

Cikkszám	Típus	Oldal
00008820560	2020 ZN29	4.183
00008820570	2020 ZN31	4.183
00008820600	2107-40 ZN1	4.178
00008820601	2107-40 ZN2	4.178
00008820610	0557/K10	4.188
00008820611	0557/MV7	4.188
00008820620	0558/K10	4.188
00008820621	0558/MV7	4.188
00008820630	1674-550 AL1A4	4.197
00008820640	1977-255 ZN1	4.192
00008820641	1977-255 ZN4	4.192
00008820650	1977-375 ZN1	4.192
00008820651	1977-375 ZN4	4.192
00008820660	2081DM-272 ZN1	4.197
00008820670	2180-100 ZN1V3S	4.192
00008820680	2226-255 ZN1BD18V1B	4.192
00008820700	743/ZN1K	4.187
00008821000	1658/N1	4.178
00008821010	2106-42 N1	4.178
00008821020	2196-300 N1V1E	4.191
00008821030	2196-460 N1V1E	4.191
00008821040	2256-300 N1V1E	4.191
00008821050	2257-340 N1V1E	4.191
00008821060	2282-42 N1	4.174
00008821080	2302/N1	4.174
00008850500	T 210	4.184
00008850600	T 210	4.184
00008850700	T 210	4.184
00008850800	T 210	4.184
00008850900	T 211	4.184
00008851000	T 211	4.184
00008851100	T 211	4.184
00008851200	T 211	4.184
00008851300	T 212	4.184
00008851400	T 212	4.184
00008851500	T 213	4.184
00008851600	T 213	4.184
00008851700	T 213	4.184
00008860000	E1000	4.186
00008860001	E1000	4.186
00008860002	E1000	4.186
00008860010	E1001	4.185
00008860011	E1001	4.185
00008860020	E1002	4.185
00008860021	E1002	4.185
00008860030	E1003	4.186
00008860031	E1003	4.186
00008860032	E1003	4.186
00008860040	E1004	4.185
00008860041	E1004	4.185

Cikkszám	Típus	Oldal
00008860042	E1004	4.185
00008860050	E1005	4.185
00008860051	E1005	4.185
00008860052	E1005	4.185
00008860060	E1006	4.185
00008860062	E1006	4.185
00008860070	E1007	4.186
00008860071	E1007	4.186
00008860072	E1007	4.186
00008860081	E1008	4.186
00008860082	E1008	4.186
00008860083	E1008	4.186
00008860091	E1009	4.186
00008860092	E1009	4.186
00008860093	E1009	4.186
00008860100	E1010	4.175
00008860110	E1011	4.175
00008860120	E1012	4.175
00008860130	E1013	4.175
00008860140	E1014	4.174
00008860150	E1015	4.174
00008865000	EM-072-A	4.187
00008865001	EM-072-A	4.187
00008865010	EM-073-A	4.187
00008865011	EM-073-A	4.187
00008870000	PA0027300	4.170
00008870001	PA0027300	4.170
00008870002	PA0027300	4.170
00008870010	PA0027100	4.170
00008870011	PA0027100	4.170
00008870012	PA0027100	4.170
00008870020	PA0027200	4.170
00008870021	PA0027200	4.170
00008870022	PA0027200	4.170
00008870031	PA0027400	4.170
00008870032	PA0027400	4.170
00008870040	PA0026700	4.171
00008870041	PA0026700	4.171
00008870042	PA0026700	4.171
00008870050	PA0028200	4.171
00008870051	PA0028200	4.171
00008870052	PA0028200	4.171
00008870061	PA0127400	4.171
00008870062	PA0127400	4.171
00008870071	PA0027900	4.172
00008870072	PA0027900	4.172
00008870081	PA0027500	4.172
00008870082	PA0027500	4.172
00008870091	LID014800	4.173
00008870101	LID014700	4.173
00008870111	LID015000	4.173
00008870121	PA0028100	4.173

## 4.210 • Bútorfogantyúk és fogasok • Cikkszám táblázat

Cikkszám	Típus	Oldal	Cikkszám	Típus	Oldal	Cikkszám	Típus	Oldal	Cikkszám	Típus	Oldal
00008870122	PA0028100	4.173	00008904030	1293 1 FOGASSAL	4.190	00008904231	S666-440	4.197	00008905360	8163	4.194
00008870131	PA0027600	4.172	00008904040	1294	4.190	00008904232	S666-440	4.197	00008905361	8163	4.194
00008870132	PA0027600	4.172	00008904050	1355-255 4 FOGASSAL	4.193	00008905000	1603-240 ZN1	4.193	00008905370	8164	4.196
00008903419	300 4 TÜSKÉVEL	4.199	00008904051	1355-255 4 FOGASSAL	4.193	00008905010	1603-240 ZN4	4.193	00008905371	8164	4.196
00008903421	300 4 TÜSKÉVEL	4.199	00008904070	1411-255 4 FOGASSAL	4.193	00008905100	H115-320 A4	4.194	00008905372	8164	4.196
00008903423	220 3 TÜSKÉVEL	4.199	00008904071	1411-255 4 FOGASSAL	4.193	00008905110	H115-320 A52	4.194	00008905380	8164 VONAT	4.196
00008903425	220 3 TÜSKÉVEL	4.199	00008904200	R-0658-390	4.198	00008905120	H115-320 A81	4.194	00008905381	8164 AUTÓ	4.196
00008903427	380 5 TÜSKÉVEL	4.199	00008904201	R-0658-390	4.198	00008905200	H115-120 A4	4.194	00008905382	8164 TÜNDÉR	4.196
00008903429	380 5 TÜSKÉVEL	4.199	00008904202	R-0658-390	4.198	00008905210	H115-120 A52	4.194	00008905390	8177 VONAT	4.196
00008903431	220 3 TÜSKÉVEL	4.199	00008904203	R-0658-390	4.198	00008905220	H115-120 A81	4.194	00008905391	8177 AUTÓ	4.196
00008903433	300 4 TÜSKÉVEL	4.199	00008904204	R-0658-390	4.198	00008905300	S641-420 HZ46	4.198	00008905392	8177 TÜNDÉR	4.196
00008903435	380 5 TÜSKÉVEL	4.199	00008904205	R-0658-390	4.198	00008905301	S641-420 HZ6	4.198	00008905400	8165-100 VONAT	4.189
00008903459	380 5 TÜSKÉVEL	4.199	00008904210	R-0658-520	4.198	00008905310	S641-280 HZ6	4.199	00008905401	8165-100 AUTÓ	4.189
00008903470	362 4 TÜSKÉVEL	4.200	00008904211	R-0658-520	4.198	00008905311	S641-280 HZ46	4.199	00008905402	8165-100 TÜNDÉR	4.189
00008903475	450 5 TÜSKÉVEL	4.200	00008904212	R-0658-520	4.198	00008905320	S592-420 HZ6	4.199	00008905410	8167	4.195
00008903505	380 3 FOGASSAL	4.200	00008904213	R-0658-520	4.198	00008905321	S592-420 HZ46	4.199	00008905411	8167	4.195
00008903530	450 4 FOGASSAL	4.200	00008904214	R-0658-520	4.198	00008905330	R-1270-400	4.196	00008905412	8167	4.195
00008903585	450 4 FOGASSAL	4.200	00008904215	R-0658-520	4.198	00008905340	8161	4.195	00008905420	8168	4.195
00008903589	300 KULCSTARTÓ	4.200	00008904220	LW0006-390	4.198	00008905341	8161	4.195	00008905421	8168	4.195
00008903591	300 KULCSTARTÓ	4.200	00008904221	LW0006-390	4.198	00008905342	8161	4.195	00008905422	8168	4.195
00008904000	1290-450 5 FOGASSAL	4.190	00008904230	S666-440	4.197	00008905350	8162	4.194	00008905430	8170	4.195
00008904010	1291-260 3 FOGASSAL	4.190				00008905351	8162	4.194	00008905440	8171	4.195
00008904020	1292 2 FOGASSAL	4.190				00008905352	8162	4.194			
						00008905353	8162	4.194			

### Z15 díszlécek, díszidomok

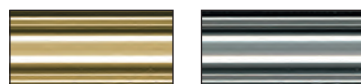

arany

ezüst



Z15-15

Z15-24

Z15-26

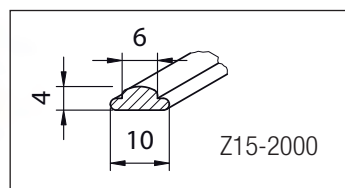

Z15-2000

díszlécek - 2 m-es szaklakban rendelhetők		
megnevezés	szín	cikkszám
Z15-2000 MF1 F	arany	00004001100
Z15-2000 MF2 F	ezüst	00004001400
díszidomok		
Z15-15 MT3	arany	00004100100
Z15-24 MT3	arany	00004100300
Z15-26 MT3	arany	00004100400

### Z22 díszlécek



barna-arany



fekete-króm

fekete-matt acél

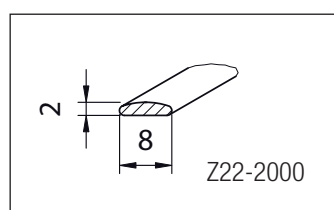

Z22-2000

### Rugalmas díszléc

díszlécek - 2 m-es szaklakban rendelhetők		
megnevezés	szín	cikkszám
Z22-2000 K2 MF1	barna-arany	00004001700
Z22-2000 K1 MF2	fekete-króm	00004001800
Z22-2000 K1 MF13	fekete-matt acél	00004001900



A struktúrlemez dekorációs céllal, beltéri felhasználásra készült, műanyag alapú díszítő elem.

Erősen igénybe vett felületek (pl.: munkalapok) esetén nem használható. Jellemző felhasználási területei:

- bútorok nem igénybevett felületeinek dekorációja (pl. tolóajtók betéteként)
- üzletek, kulturális és szórakoztató intézmények berendezései
- belsőépítészeti elemek burkolása
- kiállítások kellékeinek díszítése

Struktúrlemezeink rendelésre kaphatók. Az árat és a szállítási határidőt visszaigazolásunk tünteti fel. Öntapadós (nem nedvszívó felületekhez) és nem öntapadós változatban (nedvszívó felületekhez) egyaránt kaphatók (a tükörfóliák csak öntapadós változatban érhetőek el). A nem öntapadós változat ragasztásához a kínálatunkban megtalálható SIBUKLE ragasztó használatát javasoljuk.



#### SIBUKLE struktúrlemez ragasztó

kiszereles: 1 kg  
szállítási határidő: 4 hét  
anyagzsükséglet: 300 g/m<sup>2</sup>

00014010567

#### Termékválaszték

A struktúrlemezek megjelenés szempontjából több csoportra oszthatók. Ezek a következők:

- **Deco-line:** Minta nélküli struktúrlemezek sima vagy strukturált felülettel, széles színválasztékkal. Ezek a színek a további típusok alapszínei is. Ha a mintázatnak van száliránya, például fautánzatú vagy szálcsiszolt az mindig párhuzamos a lemez hosszirányával.
- **Structure-line:** Melegen formázott, háromdimenziós lemezek, a Deco-line termékekkel megegyező színekben.
- **Punch-line:** Különböző geometriai formákkal perforált lemezek a Deco-line termékekkel megegyező színekben. Vastagságuk a mintának megfelelően változó. 3D típusa hátulról hártyszerű filmmel burkolt, amely az áttöréseknél lencse alakú, tehát domború. Ez a film lehet áttetsző is, amely hátulról megvilágítva attraktív hatású felületet biztosít.
- **Multi-style:** Más néven tükörfóliák. A Deco-line lemezek négyzet, téglalap vagy egymással párhuzamos vonalak mentén történt bevágásával keletkeznek. Ezáltal nagyon tetszetős, hajlékony felületet kapunk, amely ideális oszlopok, vagy más íves felületek burkolására.
- **Leather-line:** Bőr- és szőrmehatású struktúrlemezek. Az erre a célra kifejlesztett elemekkel sorolhatók egymáshoz. A termék használata és feldolgozása nem különbözik a többi struktúrlemezétől.
- **Acrylic-line:** Akрил alapú, magas fényű felületek, jó karcállósággal.
- **Profilok:** A lemezek problémamentes lezárásához, toldásához és a sarokillesztésekhez külön profilok állnak rendelkezésre, amelyek kialakításukban és színeikben egyaránt illeszkednek a struktúrlemezekhez.

A teljes termékkínálatot honlapunk ([www.foresteu.com/egyedi-termekek](http://www.foresteu.com/egyedi-termekek)) valamint külön katalógusunk mutatja be.



#### SIBU The Cube termékkatalógus

Tartalmazza a struktúrlemez és tükörfóliák választékát mintákkal, rajzokkal, méretekkel

80500002005

#### Feldolgozás

A struktúrlemez feldolgozása előtt mindenképpen olvassa el a termék vásárlói tájékoztatóját. A tervezés és a feldolgozás során különösen ügyeljen az alábbiakra:

- A struktúrlemez 50°C fölötti hőforrások, spotlámpák, fűtőtestek, kályhák közvetlen közelébe nem kerülhet, erős napsütésnek kitett helyeken nem alkalmazható.
- A hőtágulás miatt mindenképpen biztosítani kell a 2 mm-es tágulási hézagot.
- Oldószeres ragasztók használatát kerüljük, mert azok hatására a struktúrlemez meglágyulhat. Helyette a kínálatunkban megtalálható Sibukle ragasztó használatát javasoljuk.
- A termék alkalmas nedves helyiségek dekorálására is, de a vízzel való közvetlen érintkezés kerülendő.
- Termékünk minőségét csak helyes feldolgozás és felhasználás esetén garantáljuk, egyéb esetekben a kárért felelősséget nem vállalunk.

A lemezek toldását és széleken történő lezárását a külön erre a célra kifejlesztett profilokkal is biztosíthatjuk.

## 4.212 • Struktúramezek



**Struktúramezeink kínálata részletesen**  
[www.foresteu.com/web/forest/egyedi-termekek](http://www.foresteu.com/web/forest/egyedi-termekek)



**Vásárlói tájékoztató**  
[www.foresteu.com/web/forest/vasarloi-tajekoztatok](http://www.foresteu.com/web/forest/vasarloi-tajekoztatok)



**Kisfilmek: tippek, trükkök, szerelés**  
[www.youtube.com/user/SIBUDesignGmbH](http://www.youtube.com/user/SIBUDesignGmbH)



### Deco-line • Leather-line



Foto: Machalke

### Structure-line • Deco-line



Foto: Pro Seda





Punch-line



Multi-style







Leather-line



Acrylic-line





**FOREST HUNGARY Kft.**

H-8900 Zalaegerszeg, Hock János u. 90/a  
Tel.: +36 92/ 507-800 • Fax: +36 92/ 507-890  
E-mail: [info@foresteu.com](mailto:info@foresteu.com) • [www.foresteu.com](http://www.foresteu.com)